

User's Guide
Models 9308, 9304 and 9302
Cryogenic Temperature Monitor

090-264 Rev. A

Scientific Instruments, Inc.

4400 W Tiffany Dr

West Palm Beach, FL 33407

Tel: (561) 881-8500

Fax: (561) 881-8556

www.scientificinstruments.com

© Copyright 2012
Scientific Instruments, Inc.
All Rights Reserved.

Printing History

Rev. A, March, 2012

Certification

Scientific Instruments, Inc. (SI) certifies that this product met its published specifications at the time of shipment. SI further certifies that its calibration measurements are traceable to the United States National Institute of Standards and Technology (NIST).

Warranty

This product is warranted against defects in materials and workmanship for a period of one year from date of shipment. During this period Scientific Instruments will, at its option, either repair or replace products which prove to be defective.

For products returned to Scientific Instruments for warranty service, the Buyer shall prepay shipping charges and Scientific Instruments shall pay shipping charges to return the product to the Buyer.

However, the Buyer shall pay all shipping charges, duties, and taxes for products returned to Scientific Instruments from another country.

Warranty Service

For warranty service or repair, this product must be returned to a service facility designated by Scientific Instruments.

Limitation of Warranty

The foregoing warranty shall not apply to defects resulting from improper or inadequate maintenance by the Buyer, Buyer supplied products or interfacing, unauthorized modification or misuse, operation outside of the environmental specifications for the product, or improper site preparation or maintenance.

The design and implementation of any circuit on this product is the sole responsibility of the Buyer. Scientific Instruments does not warrant the Buyer's circuitry or malfunctions of this product that result from the Buyer's circuitry.

In addition Scientific Instruments does not warrant any damage that occurs as a result of the Buyer's circuit or any defects that result from Buyer-supplied products.

Notice

The information contained in this document is subject to change without notice.

Scientific Instruments makes no warranty of any kind with regard to this material, including, but not limited to, the implied warranties of merchantability and fitness for a particular purpose.

Scientific Instruments shall not be liable for errors contained herein or for incidental or consequential damages in connection with the furnishing, performance, or use of this material. No part of this document may be photocopied, reproduced, electronically transferred, or translated to another language without prior written consent.

Trademark Acknowledgement

All product and company names, so marked, are trademarks or trade names of their respective companies.

Safety

The instrument does not contain any user serviceable parts. Do not open the enclosure. Do not install substitute parts or perform any unauthorized modification to the product. For service or repair, return the product to Scientific Instruments or an authorized service center.

Table of Contents

Introduction.....	1
Preparing the Monitor for Use.....	3
Model Identification.....	3
Supplied Items	3
Apply Power to the Monitor.....	3
Factory Default Setup.....	4
Technical Assistance.....	5
Returning Equipment.....	5
Options and Accessories.....	6
A Quick Start Guide to the User Interface.....	7
The Front Panel.....	7
Power ON / OFF.....	10
Restoring Factory Defaults.....	10
Clearing a latched alarm.....	10
Re-seeding the display time-constant filter.....	10
Specifications, Features and Functions.....	11
Specification Summary.....	11
Performance Summary.....	15
Input Channel Characteristics.....	16
Output Channel Features.....	19
Remote Interfaces.....	19
Mechanical, Form Factors and Environmental.....	20
The User Interface.....	23
Overview.....	23
Instrument Setup Menus.....	24
Basic Operating Procedures.....	29
Configuring a Sensor.....	29
Using NTC Sensors.....	30
Data Logging.....	31
Downloading a Sensor Calibration Curve.....	32
Using Thermocouple Sensors.....	34
Shielding and Grounding Issues.....	37
Utility Software.....	39
Installing the Utility Software.....	39
Connecting to an Instrument.....	40
Using the Interactive Terminal.....	41
Downloading or Uploading a Sensor Calibration Curve.....	42
Using the Real-Time Strip Charts.....	45
Data Logging.....	46
CalGen Calibration Curve Generator.....	48
Instrument Calibration.....	51
Calibration Services.....	51
Calibration Interval.....	51
Minimum Required Equipment.....	51
The Basic Calibration Sequence.....	52
Summary of Calibration Types.....	52
Calibration of Silicon Diodes.....	52
Calibration of DC resistors.....	53
Remote Operation.....	54
Remote Interface Configuration.....	54
Remote Programming Guide.....	59
General Overview.....	59
An Introduction to the SCPI Language.....	60
Remote Command Tree.....	65
Remote Command Descriptions.....	67

Code snippet in C++.....	75
EU Declaration of Conformity.....	77
Appendix A: Installed Sensor Curves.....	79
Factory Installed Curves.....	79
User Installed Sensor Curves.....	80
Sensor Curves on CD.....	81
User Calibration Curve File Format.....	82
Appendix B: Updating Instrument Firmware.....	85
Discussion.....	85
Updating unit firmware.....	85
Appendix C: Troubleshooting Guide.....	89
Error Displays.....	89
Temperature Measurement Errors.....	89
Appendix D: Enclosure Options.....	91
Panel Mounting.....	91
Instrument Stand.....	92
Appendix E: Sensor Data.....	93
Cryo-con S700 Silicon Diode.....	93
Scientific Instruments Si430 Silicon Diode.....	94
Cryo-con R500 Ruthenium-Oxide Sensor.....	95
Cryo-con R400 Ruthenium-Oxide Sensor.....	96
Sensor Packages.....	97
Appendix F: Configuration Scripts.....	101
Script File Structure.....	101
Script File Example.....	103
Appendix G: Sensor Data Tables.....	105
Silicon Diode.....	105
GaAIAs Diode.....	106
Platinum RTD.....	107
Rhodium-Iron.....	107
Cernox™.....	108
Ruthenium-Oxide.....	109
Appendix H: Rear Panel Connections.....	113
Rear Panel.....	113
Sensor Connections.....	114
Relay Connections.....	117
Ethernet (LAN) Connection.....	117
IEEE-488.2 Connections.....	118
RS-232 Connections.....	118
INDEX.....	119

Index of Tables

Table 1: Model Identification.....	3
Table 2: Model 9308 Instrument Accessories.....	6
Table 3: Cryogenic Accessories.....	6
Table 4: Function Key Descriptions.....	8
Table 5: Temperature Units.....	9
Table 6: Input Configurations.....	16
Table 7: PTC Resistor Sensor Configuration.....	16
Table 8: Model 9308 Root Menu.....	24
Table 9: Input Channel Setup Menus.....	25
Table 10: System Functions Menu.....	26
Table 11: Data-logging Setup Menu.....	27
Table 12: Recommended Sensor Configuration Data.....	33
Table 13: GPIB Host Setup Parameters.....	56
Table 14: Commonly Used Remote Commands.....	62
Table 15: BB Package Specifications.....	98
Table 16: Cable Color Code.....	98
Table 17: Sensor Input Connector Pinout.....	114
Table 18: Dual Sensor Cable Color Codes.....	115
Table 19: Sensor Cable Color Codes.....	115
Table 20: Thermocouple Polarities.....	116
Table 21: Relay Connections.....	117
Table 22: RS-232 DB-9 Connector Pinout.....	118

Index of Figures

Figure 1: Model 9308 Front Panel.....	7
Figure 2: Model 9308 Rear Panel.....	111
Figure 3: Input Connector.....	112
Figure 4: Diode and Resistor Sensor Connections.....	114
Figure 5: LAN RJ-45 Pinout.....	115
Figure 6: RS-232 Null Modem Cable.....	116

Introduction

Input Options: The Model 9308 has eight input channels, the 9304 has four and the 9302 has two. All inputs are identical and independent with each capable of supporting the same wide range of sensor types. Other than the input channel count, there are no differences in the monitor line.

Easy to use: The monitor's front panel consists of a large, bright TFT-LCD display a 4-key keypad, an audio alarm and three status LEDs. Several display formats may be selected. Up to eight temperature readings may be displayed simultaneously or two channels with input names and temperature shown in a large easy to read font. Additional screens include temperature readings along with relay and alarm status information.

A single key press takes the screen to a menu tree where most features and functions of the instrument can be configured.

The status of built-in alarms and relays is indicated by LEDs located below the display.

Input Flexibility: Silicon Diode sensors are supported over their full temperature range by using 10uA constant-current DC excitation.

Positive Temperature Coefficient (PTC) resistor sensors including **Platinum** and **Rhodium-Iron** RTDs use constant-current, **AC** excitation. Platinum RTD sensors have built-in DIN standard calibration curves that have been extended to 14K for cryogenic use. Lower temperature use is possible with custom calibrations.

Auto-ranged, constant-voltage AC excitation is used to provide robust support for cryogenic Negative Temperature Coefficient (NTC) sensors including **Ruthenium-oxide**, **Carbon-Glass**, **Cernox™**, **Carbon-Ceramic**, **Germanium** and several others.

Thermocouple sensors are supported by using an optional dual thermocouple module. This module plugs into any of the input channels. It is powered by the instrument to provide amplification, cold-junction compensation and connection to copper.

Input Power : The monitors are shipped with a 12VDC@1A external power supply but may be powered by any source providing 7.5 to 24 Volts AC or DC.

The IEEE 802.3af Power-over-Ethernet (PoE) specification is also supported, allowing the Model 9308 to be powered by it's local area network connection. Since PoE provides both instrument power and data over a single cable, remote data acquisition and high channel count systems can be simplified. PoE requires the use of a powered hub or power injector. Ethernet cables up to 300 meters may then be used.

Data logging: Data Logging is performed by continuously recording temperature and status to an internal circular memory buffer. Data is time stamped so that the actual time of an event can be determined. Non-volatile memory is used so that data will survive a power failure. The monitors will log up to 800 samples. Each sample includes readings for all input channels.

Alarms and Relays: Two 10.0A dry-contact relay outputs are available that can be asserted based on temperature setpoints from user selected input channels. These relays are large enough to switch most cryogenic valves.

The visual, remote and audible alarms are supported. Each may be programmed to assert or clear based on temperature setpoints.

Alarms may be latched. These are asserted on an alarm condition and will remain asserted until cleared by the user.

① Note: A latched alarm may be cleared by pressing the **Right Arrow (▶)** key on the front panel when the Home Status screen is displayed.

Remote Control: Standard Remote Interfaces include 100/10 Ethernet and RS-232.

An **IEEE-488.2** GPIB interface is optional and may be field installed at any time. The option consists of an external module that is automatically configured by the monitor. A USB 2.0 serial port emulator option is also available.

Monitors connect directly to any **100/10 Ethernet Local-Area-Network (LAN)**.

The **TCP** and **UDP** data port servers bring fast Ethernet connectivity to data acquisition software including LabView™.

Using the **SMTP** protocol, the monitor will send e-mail based on selected alarm conditions.

Using the Ethernet **HTTP** protocol, the monitor's **embedded web server** allows the instrument to be viewed and configured from any web browser.

Remote interfaces implement an IEEE-488.2 SCPI compliant remote command language that is easy to learn and easy to read. This language is identical across all multichannel monitor products to ensure that your investment in system software is always protected.

LabView™ drivers are available for all remote interfaces.

Remote Command Language: The Monitor's remote command language is SCPI compliant according to the IEEE-488.2 specification. SCPI establishes a common language and syntax across various types of instruments. It is easy to learn and easy to read.

Command Scripts can be used to completely configure an instrument including setting custom sensor calibration curves and PID tables. Further, scripts can query and test data. They are commonly used in a manufacturing environment to set a baseline state and test a target product. In the laboratory, scripts can be used to save and restore configurations for various experiments.

XML (Extensible Markup Language) is used for the structure and format of script files. XML can be generated and edited with a standard text editor. Further, it is easy to read and understand.

Firmware Updates: Full instrument firmware updates may be installed by using the Ethernet connection. Updates are free of charge and generally include enhancements and new features.

Ethernet API: An Applications Program Interface (API) package is supplied that facilitates communication with the instrument using the TCP/IP and UDP protocols. It is supplied as a Microsoft Windows™ DLL that is easily linked with C, C++ or Basic programs.

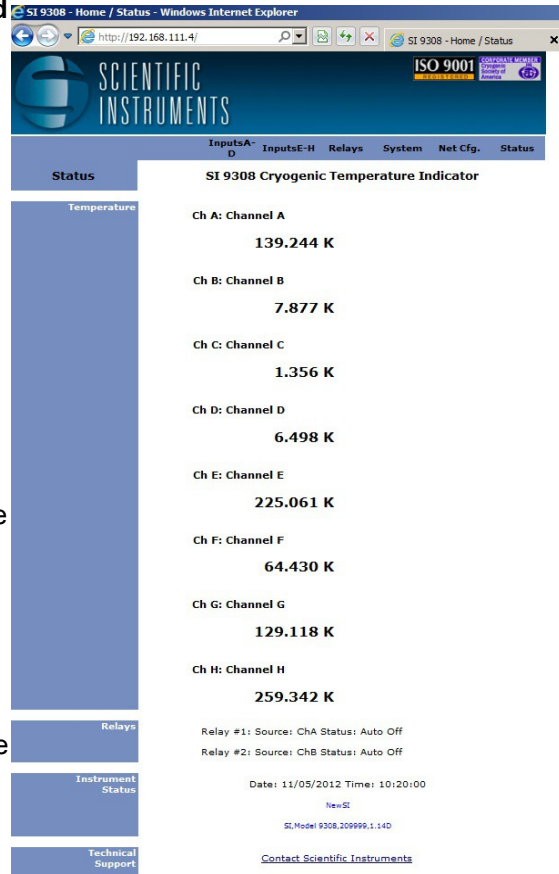

Preparing the Monitor for Use

Model Identification

The model number is identified on the front and rear panel of the instrument as well as in various instrument displays.

Part Number	Description
Model 9308	Eight-channel monitor. Includes 12VDC external power supply.
Model 9304	Four-channel monitor. Includes 12VDC external power supply.
Model 9302	Two-channel monitor. Includes 12VDC external power supply.
120-659	Dual thermocouple Input Module. Field installable. Supports all thermocouple types.
405-093	Single Power-over-Ethernet Power injector.
120-670	IEEE-488.2 (GPIB) Option. Field installable.
120-671	USB 2.0 Option. Serial Port Emulation. Field installable.
231-587	Relay connector. 4-pin detachable terminal block.

Table 1: Model Identification

Supplied Items

Verify that you have received the following items with your monitor. If anything is missing, contact Cryogenic Control Systems, Inc. directly.

- Cryogenic Temperature Monitor.
- User's Manual (PN 090-264).
- SI software CD, (PN 093-033).
- Four, two or one dual-input connector/cable assemblies (PN 402-015).
- External Power Supply. 12VDC @ 1.0A. Universal Voltage Input. (PN 490-061).
- Certificate of Calibration.

Apply Power to the Monitor

Connect the supplied external power supply to the monitor and plug it into an AC power outlet. The supply accepts 100 – 240 VAC at 50 – 60 Hz.

ⓘ NOTE: The monitor has a power key on the front panel. To turn power ON or OFF, press and hold the power (■) key for two seconds.

ⓘ Note: The monitor uses a smart power on/off scheme. When the power button on the front panel is pressed to turn the unit off, the instrument's setup is copied to flash memory and restored on the next power up. If the front panel button is not used to toggle power to the instrument, the user should configure it and cycle power from the front panel button one time. This will ensure that the proper setup is restored when AC power is applied.

While the Power Up display is shown, the monitor is performing a self-test procedure that verifies the proper function of internal data and program memories, remote interfaces and input channels. If an error is detected during this process, the monitor will freeze operation with an error message display. In this case, turn the unit off and refer to [Appendix B: Troubleshooting Guide](#).

```
SI Model 9308
SN: 209999      Rev: 1.14D
IP: 192.168.1.4
IP Adrs Mode: Static
Port: 5000      Connected
                00:50:C2:6F:42:38
NVRAM: Valid
Self Test Passed
```



Caution: Do not remove the instrument's covers or attempt to repair it. There are no user serviceable parts, jumpers or switches inside the unit. Further, there are no software ROM chips, batteries or battery-backed memories. All firmware installation and instrument calibration functions are performed externally via the remote interfaces.

After about ten seconds, the self-test will complete and the monitor will begin normal operation.

NOTE: The Model 9308 attempts to connect with the Ethernet as soon as power is applied. If there is a valid Ethernet connection, the power-up sequence is immediate. However, if there is no connection, the Model 9308 will delay about 10 seconds before showing the power-up screen.

Factory Default Setup

A monitor with factory default settings will have an operational display like the one shown here. The dash (-) or dot (.) characters indicate that there is no sensor connected.

Note that, in some cases, there will be an erratic temperature display when no sensor is connected. This is not an error condition. The high input impedance of the monitor's input preamplifier causes erratic voltage values when unconnected.

```
A : -----K
B : -----K
C : -----K
D : -----K
E : -----K
F : -----K
G : -----K
H : .....K
```

Input Channel factory defaults are:

- Sensor Units: Kelvin.
- Sensor Type: Pt100 385 (DIN standard 100Ω Platinum RTD)
- Alarm Enables: Off

To change these, press the **Enter (■)** key then refer to the [Input Channel Setup Menu](#) section.

Instrument setup factory defaults are:

- Display Filter Time Constant: 4.0 Seconds.
- Display Resolution: 3 digits.
- Data Logging: Off

To change these, press the **Enter (■)** key and then select the [System Setup Menu](#).

Network settings are:

- IP Address: 192.168.1.4.
- Subnet Address: 255.255.255.0

NOTE: Factory defaults may be restored at any time by use of the following sequence: 1) Turn power to the monitor OFF. 2) Press and hold the **Right Arrow (▶)** key while turning power back ON.

Technical Assistance

Trouble shooting guides and user's manuals are available on our web page at <http://www.scientificinstruments.com>.

Technical assistance may also be obtained by contacting Scientific Instruments as follows:

Scientific Instruments, Inc.
4400 W Tiffany Dr
West Palm Beach, FL 33407

Telephone: 561 881-8500 FAX: 561 881-8556
e-mail: sales@scientificinstruments.com

Current Firmware Revision Level

As of October, 2012 the current firmware revision level for the C series is 1.14D.

Current Hardware Revision Level

As of October, 2012, the current hardware revision level is Rev. D. Hardware cannot be upgraded in the field.

Returning Equipment

If an instrument must be returned to SI for repair or recalibration, a Return Material Authorization (RMA) number must first be obtained from the factory. This may be done by Telephone, FAX or e-mail.

When requesting an RMA, please provide the following information:

1. Instrument model and serial number.
2. User contact information.
3. Return shipping address.
4. If the return is for service, please provide a description of the malfunction.

If possible, the original packing material should be retained for reshipment. If not available, consult factory for packing assistance.

SI's shipping address is:

Scientific Instruments, Inc.
4400 W Tiffany Dr
West Palm Beach, FL 33407

Options and Accessories

Instrument Accessories

SI Part #	Description
402-015	Dual Sensor Cable, 2 x 8 foot
402-014	Shielded Sensor Connector Kit (DB9)
305-240	Panel Mount hardware kit. See Appendix C
300-010	Bench top instrument stand. See Appendix C
300-011	Tilt-stand and carry handle. Appendix C
090-264	Additional User's Manual/CD

Table 2: Model 9308 Instrument Accessories

Cryogenic Accessories

SI Part #	Description
Si410/Si420	Si410 series Silicon Diode Temperature Sensors. Temperature range: 1.4 to 450K.
Si430/Si440	Si430 series Silicon Diode Temperature Sensors. Temperature range: 1.4 to 400K (Si430) or 500K (Si440)
Pt100	Pt100 series Ceramic Wound RTD, 100 Ω
RO105	Ruthenium-Oxide. Temperature range is 1.4 to 40K. Commonly used with superconducting magnets.
RO600	Ultra-low temperature Ruthenium-Oxide. Temperature range is 1.0 to 40K.

Table 3: Cryogenic Accessories

A Quick Start Guide to the User Interface.

The Front Panel



Figure 1: Model 9308 Front Panel

Home Status Displays

The instrument powers up with the home status display. This is a status-only display and the contents are user selectable.

The factory default display is shown here. It shows all eight channels plus alarm indicators. Here, the – characters indicate no alarm. The Model 9308 has nine different Home Status displays that can be viewed and selected by pressing the **Right Arrow (▶)** key.

A:	K	--
B:	K	--
C:	K	--
D:	K	--
E:	K	--
F:	K	--
G:	K	--
H:	K	--

Several displays show temperature information in a large, easy to read font. Also shown is the input channel name. This name is a convenience that allows easy association of the input channel with it's actual connection. Channel names may be entered by use of the embedded web site or via any of the remote interfaces.

A:	Sample Holder
	123.456K
B:	Rad. Shield
	234.567K

Navigating the Menu Tree

Setup and configuration functions are performed by working with the monitor's menu tree. To access this tree from the Home Status display, press the **Enter (■)** key.

Navigation through all menus is performed by pressing the **Up ▲** or **Down ▼** keys. A cursor will scroll up or down to show additional lines. Moving up the tree is done by pressing the **Right Arrow (▶)** key. Note that the Home Status display is at the top of the tree.

The left most character on each line of a menu is the cursor. These cursors are used as follows:

■ Indicates a selectable line. Pressing the **Enter (■)** key will select the function described on the menu line.

+ Indicates that the line is an enumeration field. Pressing the **Enter (■)** key will cause the cursor to flash. Then, pressing the **Right Arrow (▶)** key will sequence through the allowed choices for the line. To make a selection, press the **Enter (■)** key again. To abort the selection process without making any change, press either the **Up ▲** or **Down ▼** key.

Indicates that the selection is a numeric entry field. To change the value displayed, press the **Enter (■)** key and the cursor will flash. Then, press the **Up ▲** key to increment the number or the **Down ▼** key to decrement the number. When the desired value is shown, press the **Enter (■)** key. Or, to abort entry without making any changes, press either the **Up ▲** or **Down ▼** key.

Note that it is much easier to enter numbers from the embedded web page or from a remote interface.

Key	Description
■	1) From Home screen, go to the top level setup menu. 2) Within a setup menu, Enter data or select a field (cursor display will indicate function). 3) Press and hold this key for two seconds to toggle AC power.
▲	1) Scroll Display UP. 2) When in a field selection mode, abort entry and return to scroll mode. 3) In a numeric field, increment.
▼	1) Scroll Display DOWN. 2) When in a field selection mode, abort entry and return to scroll mode. 3) In a numeric field, decrement.
▶	1) Move up the menu tree one level eventually returning to the Home Status display. 2) In selection mode, scroll to next selection.

Table 4: Function Key Descriptions.

Example Menu

Shown here is an example input channel setup menu with all of the cursor characters displayed.

Pressing the **Up ▲** or **Down ▼** keys will move the cursor. Additional lines will be displayed after the last line shown.

The first line is the channel indicator and channel name. pressing the **Enter (■)** key will cause the cursor to flash, then, each time the **Right Arrow (▶)** key is pressed, the next sequential input channel will be shown. Finally, pressing the **Enter (■)** key again will select the displayed channel menu.

```
+ChA: Sample Holder
+ 123.456 K
+A: 20 Pt100 385
+A: BiasVoltage: N/A
+A: Bridge: Auto
#A: Hi Alarm: 100.00
+A: Hi Alarm Ena: No
#A: Lo Alarm: 10.000
```

The second line is an enumeration. It shows the temperature reading in real-time and allows the selection of temperature units. Pressing the **Enter (■)** key will cause the cursor to flash. Then, pressing the **Right Arrow (▶)** key will sequence through the allowed choices of K, C, F or S. To make a selection, press the **Enter (■)** key again.

The sixth line is a numeric entry. To change the value displayed, press the **Enter (■)** key and the cursor will flash. Then, press the **Up ▲** key to increment the number or the **Down ▼** key to decrement the number. When the desired value is shown, press the **Enter (■)** key.

LED indicators

There are three LED indicators on the right hand side of the instrument. They indicate the following:

- Alarm (Red) – An enabled alarm condition is asserted.
- Relay 1 (Green) and Relay 2 (Green) - Relay asserted.

The Input Channel Temperature Displays

Temperature displays are a seven-character field and is affected by the Display Resolution setting in the system menu. This setting will be 1, 2, 3 or Full. Settings of 1, 2, or 3 indicate the number of digits to the right of the decimal point to display whereas the Full setting causes the display to be left justified in order to display the maximum number of significant digits possible.

If the sensor type is None, the Input Channel has been disabled and a blank line is shown.

Temperature units are selected in the individual input channel setup menus. Temperature Units may be K, C or F. When Sensor Units (S) is selected, the raw input readings are displayed. These will be in Volts, Ohms or milli-Volts depending on the specific sensor.

K	Kelvin
C	Celsius
F	Fahrenheit
Ω	Ohms
V	Volts
m	millivolts

Table 5: Temperature Units

A sensor fault condition is identified by a temperature display of seven dash (-) characters as shown here. The sensor is open, disconnected or shorted.

-----K

If a temperature reading is within the measurement range of the instrument but is not within the specified Sensor Calibration Curve, a display of seven dot (.) characters is shown.

.....K

Power ON / OFF

Pressing the **Power** (■) key will toggle the instrument's power on and off. This key must be pressed and held for two seconds before power will toggle.

① **Note:** The Model 9308 uses a smart power on/off scheme. When the power button on the front panel is pressed to turn the unit off, the instrument's setup is copied to flash memory and restored on the next power up. If the front panel button is not used to toggle power to the instrument, the user should configure it and cycle power from the front panel button one time. This will ensure that the proper setup is restored when power is applied.

Restoring Factory Defaults

Factory default settings may be restored with the following simple procedure:

1. Turn power OFF by pressing the **Enter** (■) key for two seconds or disconnecting power.
2. Press and hold the **Right Arrow** (▶) key while turning power back ON. Keep the key pressed until you see the power-up display indicating that defaults have been restored.

Clearing a latched alarm

When a latched alarm is asserted, pressing the **Right Arrow** (▶) key will clear it.

Re-seeding the display time-constant filter

The display time-constant filter may be set up to 64 seconds and therefore, might take an exceptionally long time to settle if some event has caused a quick change in the input temperature. Re-seeding the filter will cause the display to immediately settle at the new temperature.

To re-seed the filter, navigate to the Home Status display and press the **Right Arrow** (▶) key. The displayed temperature should immediately stabilize.

Under remote control, use the SYS:RESEED command.

Specifications, Features and Functions

Specification Summary

User Interface

Display Type: 21 x 8 character or 128x64 graphics TFT LCD.

Number of Inputs Displayed: Up to Eight.

Keypad: Sealed Silicon Rubber.

Temperature Display: Six significant digits, autoranged.

Display Update Rate: 0.5 Seconds.

Display Units: K, C, F or native sensor units.

Display Resolution: User selectable to seven significant digits.

Input Channels

Input channels are identical and each may be independently configured for any of the supported sensor types.

Sensor Connection: 4-wire differential. DB-9 receptacles connect two channels. Connections are described in the “[Sensor Connections](#)” section.

Isolation: Sensor circuits are not electrically isolated from other internal circuits. However, there is a ‘single point’ internal connection to Earth (or Shield) ground in order to minimize noise coupling.

Input Protection: ± 30 Volts maximum.

Supported Sensors: Include:

Type	Excitation	Temperature Range
Cernox™	Constant-Voltage AC	1.4K to 420K
Ruthenium-Oxide	Constant-Voltage AC	1.4K to 273K
Germanium	Constant-Voltage AC	4.2K to 100K
Carbon Glass	Constant-Voltage AC	1.4K to 325K
Silicon Diode	10 μ A DC	1.4 to 500K
Rhodium-Iron	Constant-Current, 1mA AC	1.4 to 800K
Platinum RTD	Constant-Current, 1mA AC	14 to 1200K
GaAlAs Diode	10 μ A DC	25K to 325K
Thermocouple	None	1.4 to 1500K

Sensor Selection: Front Panel or remote interface. There are no internal jumpers or switches.

Sample Rate: 15Hz per channel in all measurement modes.

Digital Resolution: 24 bits.

Measurement Filter: 0.5, 1, 2, 4, 8, 16, 32 and 64 Seconds.

Calibration Curves: Built-in curves for industry standard sensors plus eight user curves with up to 200 entries each. Interpolation is performed using a Cubic Spline.

CalGen®: Calibration curve generator fits any Diode or resistor sensor curve at 1, 2 or 3 user specified temperature points. CalGen® is implemented in the Utility software provided with the indicator.

Sensor Performance

Diode Sensors

Configuration: Constant-Current, 10 μ A \pm 0.05% DC excitation.
Input voltage range: 0 to 2.20VDC.
Accuracy: $\pm(60\mu\text{V} + 0.005\% \cdot \text{reading})$
Resolution: 2.3 μ V
Drift: <15ppm/ $^{\circ}$ C

PTC Resistor Sensors

Configuration: Constant-Current AC resistance.
Drift: 15ppm/ $^{\circ}$ C
Excitation Frequency: 1.625Hz bipolar square wave.

Range	Max/Min Resistance	Excitation Current	Resolution	Accuracy
PTC100 1mA	625 Ω 0.01 Ω	1.0mA	0.1m Ω	$\pm (0.002 + 0.01\%)\Omega$
PTC1K 100 μ A	6.25K Ω 0.1 Ω	100 μ A	1.0m Ω	$\pm (0.03 + 0.02\%)\Omega$
PTC10K 10 μ A	62.5K Ω 1.0 Ω	10 μ A	10m Ω	$\pm (3.0 + 0.02\%)\Omega$

Table 6: Accuracy and Resolution for PTC Resistors

NTC Resistor Sensors, DC measurement

Configuration: NTC10 μ A
Excitations: Constant Current 10 μ A \pm 0.5% DC
Measurement Drift: 25ppm/ $^{\circ}$ C
Range: 230K Ω to 50K Ω .
Accuracy: $\pm (3.0 + 0.02\%)\Omega$
Resolution: 100m Ω

Note: The NTC10 μ A range is intended for use with NTC sensors that have over 100K Ω of resistance. These sensors are commonly used in superconductor systems and include the SI RO105 Ruthenium-Oxide devices. All other NTC resistor sensors should use the constant-voltage configurations.

Thermocouple Sensors

Thermocouple devices are supported by using an optional external module.

Measurement Drift: 15ppm/ $^{\circ}$ C **Input Range:** \pm 70mV
Accuracy: \pm 1.0 μ V \pm 0.05%. **Resolution:** 0.0003%
Installed Types: K, E, T and Chromel-AuFe (0.07%).
Input Connector: Isothermal, Screw-type terminals.

NTC Resistor Sensors

Type: Constant-Voltage AC resistance bridge with excitations of 100mV and 10mV RMS. Fixed or auto-ranged.

Excitation Current: 1.0mA to 0.1µA.

Three ranges of 1.0mA, 100µA and 1.0µA.

Excitation Frequency: 1.67Hz bipolar square wave.

Accuracy (% reading + % range):

Reading >4Ω and < 30KΩ : ±(0.05% + 0.05%).

Reading >0.04Ω and < 1.0MΩ : ±(0.15% + 0.15%).

Drift: >10Ω, 15ppm/°C. <10Ω, 25ppm/°C

DC Offset Current: < 0.2µA by continuous calibration.

Resistance Range: 0.5Ω to 2.0MΩ.

Resistance	100mV	10mV
Maximum	1.0MΩ	1.0MΩ
Minimum	80Ω	8.0Ω

Table 7: Minimum and Maximum Resistance vs. Bias Voltage

Data Logging

Data logging of input channel data is performed into an internal, 40K byte circular buffer and is time-stamped with a real-time clock. Buffer memory is non-volatile and will retain valid data indefinitely without input power. The Model 9308 will log a maximum of 1,000 entries where each entry contains eight temperature readings.

Status Outputs

Visual Alarms: Independent visual alarms can be configured for each input. They are displayed on the front panel as text characters and an LED indicator.

Status reported via Remote Interface: Input channel alarms.

Relay Outputs

Number: 2

Type: Dry-contact.

Contact ratings: 10A@125 VAC, 5A@250VAC or 5A@30VDC.

Function: Asserted or cleared based on temperature setpoint data.

Deadband: User defined.

Connector: 4-pin detachable terminal block.

Remote Interfaces

Remote interfaces are electrically isolated to prevent ground loops.

Ethernet: Industry standard 10-BaseT. Electrically isolated

RS-232: Serial port is an RS-232 standard null modem.

Rates are 9600, 19,200, 38,400 and 57,200 Baud.

IEEE-488 (GPIB): External option. Full IEEE-488.2 compliant.

USB 2.0: External option. Serial port emulator.

Language: Remote interface language is IEEE-488.2 SCPI compliant.

Compatibility: National Instruments LabView™ drivers available for all interfaces.

Ethernet API available for C++ and Basic.

Firmware

Internal firmware and all data tables are maintained in FLASH type memory.

General

Ambient Temperature: $25^{\circ}\text{C} \pm 5^{\circ}\text{C}$ for specified accuracy.

Mechanical: 5.75"W x 2.875"H x 8.75"D.

Weight: 3 Lbs.

Enclosure: Aluminum Extrusion. Machined Aluminum front and rear panels.

Power Requirement: Input voltage is 7.5 to 48V, AC or DC, 10VA.

1. External transformer (Provided). Input 100 – 240VAC @ 50 – 60Hz.
2. IEEE-802.3at Power-Over-Ethernet (requires powered hub or injector)

Performance Summary

Measurement Accuracy

Diode Sensors

The formulas for computing measurement accuracy while using diode sensors are:

$$MAV = 60 \cdot 10^{-6} + 5 \cdot 10^{-5} \cdot \text{SenRdg}$$

$$MAT = \frac{MAV}{\text{SenSen}}$$

Where:

MAV is the electronic Measurement Accuracy in Volts

MAT is the Measurement Accuracy in Kelvin

SenRdg is the sensor reading in Volts at the desired temperature.

SenSen is the sensor sensitivity in Volts / Kelvin at the desired temperature.

For example, if we want to calculate measurement accuracy using a S1410 sensor at 10K, we would look up the sensor reading and sensitivity in the Si410 data table in [Appendix E](#). At 10K, we see that SenRdg is 1.3956 Volts and SenSen is 0.0326 Volts/Kelvin . Therefore,

$$MAV = 60 \cdot 10^{-6} + 5 \cdot 10^{-5} \cdot 1.3956$$

and

$$MAT = \frac{MAV}{0.0326}$$

The result is that MAV = 130μV and MAT = 4mK.

PTC and NTC Resistor Sensors

The formulas for PTC and NTC resistor sensors are stated above. As an example, here is a computation for a PTC resistor with the PTC100 input configuration:

Where:

$$MAR = 0.002 + 1.0 \cdot 10^{-4} \cdot \text{SenVal}$$

$$MAT = \frac{MAR}{\text{SenRdg}}$$

MAR is the electronic Measurement Accuracy in Ohms

MAT is the Measurement Accuracy in Kelvin

SenRdg is the sensor reading in Ohms at the desired temperature.

SenSen is the sensor sensitivity in Ohms / Kelvin at the desired temperature.

To calculate measurement accuracy using a 100Ω Platinum RTD in the PTC100 range with the sensor at 77.35K, we would look up the sensor reading and sensitivity in [Appendix E](#). and see that SenRdg is 20.38Ω and SenSen is 0.423 Ω/Kelvin. Therefore, we compute MAR = 0.004038Ω and MAT = 9.5mK.

Input Channel Characteristics

There are eight independent, multi-purpose input channels; each of which can separately be configured for use with any supported sensor.

The sensor type is selected by the user and this establishes the input configuration. Values of excitation current, voltage gain etc. will be determined by the microprocessor and used to automatically configure the channel. There are no jumpers or optional cards required to configure the various sensors.

Input Configurations

A complete list of the input configurations supported by the Model 9308 is shown below:

Sensor Type	Max. Voltage/ Resistance	Bias Type	Excitation Current
Diode	2.20V	CI	10µA DC
ACR	8Ω to 1.0MΩ	CV	1.0mA to 0.1µA AC
PTC100	0.5 - 750Ω	CI	1.0mA DC
PTC1K	5 - 7.5KΩ	CI	100µA DC
PTC10K	50 75KΩ	CI	10µA DC
NTC10UA	240KΩ	CI	10µA DC
TC70	±70mV	None	0
None	0	None	0

Table 6: Input Configurations

Bias types are:

- CI** – Constant Current through the sensor.
- CV** – Constant Voltage-drop across the sensor.

Note: A complete listing of factory installed sensors and their characteristics can be found in [Appendix A](#).

Note: Any disconnected inputs to the Model 9308 should be set to type 'None'. This will turn the input off.

Silicon Diode Sensors

Silicon Diode sensors (2-Volt diodes) are configured with a 10µA current source excitation and a 2.2Volt input voltage range.

PTC Resistor Sensor (RTDs)

The Model 9308 supports all types of Positive-Temperature-Coefficient (PTC) resistive sensors using a constant-current AC resistance measurement technique.

Standard calibration curves are provided for DIN43760 and IEC751 Platinum sensors. These curves have been extended down to 14K. Below that, the sensors can be used with user supplied calibration curves.

A table of recommended setups for various types of PTC resistor sensors is shown here:

Type	Measurement Range	Sensor Excitation
Platinum, 100Ω	625Ω - 0.01Ω	1.0mA, AC
Platinum, 1000Ω	6.25KΩ - 0.1Ω	100µA, AC
Platinum, 10KΩ	62.5KΩ - 1.0Ω	10µA, AC
Rhodium-Iron	6.25Ω - 0.01Ω	1.0mA, AC

Table 7: PTC Resistor Sensor Configuration

NTC Resistor Sensors > 100KΩ

Ruthenium-Oxide sensors used in superconducting magnet systems commonly have a room temperature resistance of > 100KΩ. The Model 9308 supports these devices using 10μA DC constant-current excitation. The maximum resistance is 220KΩ. DC excitation is used since the high resistance values do not benefit from AC excitation. In addition, 10μA constant-current is implemented because the extremely small current used by constant-voltage modes would lead to measurement noise.

Sensor self-heating caused by the high level excitation is calibrated out in the sensor's calibration curve. Since this self-heating is reproducible, high measurement accuracy is maintained.

Examples of high resistance sensors include the Scientific Instruments RO105 and the Cryo-con R400.

NTC Resistor Sensors

The Model 9308 supports almost all types of Negative-Temperature-Coefficient (NTC) resistive sensors by using a constant-voltage AC resistance bridge technique, these sensors can be used down to very low temperatures. Examples of NTC resistor sensors include: Ruthenium Oxide, Cernox™, Carbon Glass, Germanium and other thermistors.

Constant-voltage excitation is necessary since the resistance thermometers used below about 10K exhibit a negative temperature coefficient. Therefore, a constant-voltage measurement reduces the power dissipation in the sensor as temperature decreases. By maintaining low power levels, sensor self-heating errors that occur at very low temperatures are minimized.

In the constant-voltage mode, sensor excitation is a 1.67Hz bipolar square-wave. This provides DC offset cancellation without loss of signal energy. DC offsets are held to <0.2μA in order to minimize its contribution to sensor self-heating.

For more information on using the Model 9308 with NTC resistor sensors, please refer to the section titled "[Selecting a Voltage Bias for NTC Sensors](#)".

Power dissipation in the sensor is computed by:

$$P_d = \frac{V_{bias}^2}{R_{sensor}}$$

When used with high resistances, measurement accuracy steadily degrades due to the extremely low excitation current required. The trade-off in measurement accuracy vs. sensor excitation current is taken for two reasons:

- ❑ The sensitivity of NTC resistor sensors is extremely high in the low temperature end of their range. Therefore the reduced measurement accuracy does not degrade temperature measurement accuracy.
- ❑ The low current settings are required since sensor self-heating at low temperature is a very significant source of errors.

For more information please refer to the section titled "[Selecting a Voltage Bias for NTC Sensors](#)"

Calibration tables for NTC sensors may be entered either directly in Ohms or in (base 10) Log of Ohms to accommodate the generally logarithmic nature of their calibration curves.

Gallium-Arsenide Diode Sensors

Gallium-Arsenide diodes or 6-Volt diodes are sometimes used in systems where magnetic fields are present. Use is limited to operation above about 30K with fields of less than 5T. The Model 9308 supports these sensors down to 25K. If your requirements are for lower temperature operation, Ruthenium-Oxide is a better choice.

Gallium-Arsenide sensors do not fit standard calibration curves, therefore, the user must provide a sensor-specific curve before using this type of sensor.

CalGen Calibration Curve Generator

The CalGen® feature generates new calibration curves for Silicon diode, thermocouple or Platinum sensors. This provides a method for obtaining higher accuracy temperature measurements without expensive sensor calibrations.

Curves can be generated from any user-selected curve and are written to a specified internal user calibration curve area.

Calgen is implemented in the utilities software.

Input Channel Statistics

Input temperature statistics are continuously maintained on each input channel. This data may be viewed in real time on the Input Channel menu, or accessed via any of the remote I/O ports.

Statistics are:

- Minimum Temperature.
- Maximum Temperature.
- Temperature Variance.
- Slope and Offset of the best-fit straight line to temperature history.
- Accumulation Time

The temperature history may be cleared using a reset command provided.

Electrical Isolation and Input Protection

The input channel measurement circuitry is not isolated from other internal circuits. The common mode voltage between an input sensor connection and the instrument's ground should not exceed $\pm 40V$.

Sensor inputs and outputs are provided with protection circuits. The differential voltage between sensor inputs should not exceed $\pm 15V$.

Thermal EMF and AC Bias Issues

DC offsets build up in cryogenic temperature measurement systems due to thermocouple effects within the sensor wiring, though careful wiring minimizes these effects. However, in a few systems, measurement errors induced by thermal EMFs result in unacceptable measurement errors. These cases require the use of an AC bias, or chopped sensor excitation in order to remove DC offsets.

Sensor Wiring

Diode and Platinum RTD type sensors use a DC measurement scheme. Therefore, the only effective method of minimizing thermocouple (DC) offsets is to wire temperature sensors so that connections between dissimilar metals are grouped together. For example, the connection between sensor leads and cryostat wiring should be kept close together. This way, the thermocouple junctions formed by the connection have equal-but-opposite voltages and cancel each other.

In a four-wire measurement scheme, only connections in the voltage sense lines can cause measurement errors. Therefore, the sense wires should have adjacent contacts in a multi-pin connector in order to minimize any temperature difference between them.

Usually, the 'connection to copper' in a cryostat is made at the top of the cryostat. After this point, Thermal EMFs cannot be generated.

AC Excitation

When a resistance sensor is selected, the Model 9308 uses a square-wave sensor excitation. This eliminates DC offsets by computing the sensor resistance at two different excitation points.

Output Channel Features

Alarm Outputs

Alarm outputs include a LED indicator, an audible alarm, on-screen display and remote reporting.

Alarms may be asserted based on high temperature or low temperature condition. A user selectable dead-band is applied to all alarms.

The High and Low temperature alarms may be latched. See the Input Channel Configuration Menu.

ⓘ Note: A latched alarm may be cleared by pressing the **Right Arrow (▶)** key on the front panel when the Home Status screen is displayed.

Relays

The Model 9308 has two large dry-contact mechanical relay outputs.

Relays are asserted or cleared based on the temperature reading of selected input channels. Each output has a high and low set-point that may be enabled from the front panel or a remote interface. Furthermore, relays can be manually asserted ON or OFF.

Normally-Open contacts are available on the rear panel. Contact ratings: 10A@125 VAC, 5A@250VAC or 5A@30VDC.

Remote Interfaces

Ethernet LAN and RS-232 interfaces are standard. IEEE-488.2 (GPIB) and USB are external, field installable options. All functions and read-outs available from the instrument may be completely controlled by any of these interfaces.

The LAN interface is electrically isolated and is 10/100-BaseT compliant. Connection is made via the RJ-45 connector on the rear panel.

The Serial port is an RS-232 standard null modem with male DB9 connector. Rates are 9600, 19,200, 38,400 and 57,200 Baud.

When installed, the GPIB option is fully IEEE-488.2 compliant. Connection is made at the rear panel's LAN port.

The USB option is a serial port emulator.

The programming language used by the Model 9308 is identical for all interfaces and is SCPI language compliant. The Standard Command Protocol for programmable Instruments (SCPI) is a sub section of the IEEE-488.2 standard and is a tree structured ASCII command language that is commonly used to program laboratory instruments.

Mechanical, Form Factors and Environmental

Display

The display is an eight line by twenty-character graphic TFT-LCD.

Enclosure

The Model 9308 is bench mountable. Rack mounting can be done by using an optional rack mount kit.

Dimensions are: 5.75"W x 2.875"H x 8.75"D. Weight is 3Lbs.













Environmental and Safety Concerns.

Safety

The Model 9308 protects the operator and surrounding area from electric shock or burn, mechanical hazards, excessive temperature, and spread of fire from the instrument.

- **Keep Away From Live Circuits:** Operating personnel must not remove instrument covers. There are no internal user serviceable parts or adjustments. Refer instrument service to qualified maintenance personnel. Do not replace components with power cable connected. To avoid injuries, always disconnect power and discharge circuits before touching them.
- **Cleaning:** Do not submerge instrument. Clean exterior only with a damp cloth and mild detergent only.
- **Grounding:** To minimize shock hazard, the instrument is equipped with a three-conductor AC power cable. Plug the power cable into an approved three-contact electrical outlet only.

Safety Symbols

	Direct current (power line).		Equipment protected throughout by double insulation or reinforced insulation (equivalent to Class II of IEC536).
	Alternating current (power line).		Caution: High voltages; danger of electric shock. Background color: Yellow; Symbol and outline: Black.
	Alternating or direct current (power line).		Caution or Warning - See instrument documentation. Background color: Yellow; Symbol and outline: Black.
	Three-phase alternating current (power line).		Fuse.
	Earth (ground) terminal.		
	Protective conductor terminal.		
	Frame or Chassis terminal.		
	On (AC Power)		
	Off (AC Power)		

Environmental Conditions

Environmental conditions outside of the conditions below may pose a hazard to the operator and surrounding area:

- Indoor use only.
- Altitude to 2000 meters.
- Temperature for safe operation: 5 °C to 40 °C.
- Maximum relative humidity: 80% for temperature up to 31 °C decreasing linearly to 50% at 40 °C.
- Power supply voltage fluctuations not to exceed $\pm 10\%$ of the nominal voltage.
- Over voltage category II.
- Pollution degree 2.
- Ventilation: The instrument has ventilation holes in its side covers. Do not block these holes when the instrument is operating.
- Do not operate the instrument in the presence of flammable gases or fumes. Operation of any electrical instrument in such an environment is a definite safety hazard.

The User Interface

Overview

The Cryogenic Temperature monitor's user interface consists of an eight line by 21-character TFT LCD display and a four key keypad. Most features and functions of the instrument can be accessed via this simple and intuitive menu driven interface. Complex functions, such as downloading a new sensor calibration curve, require using one of the remote interfaces.

The instrument powers up with the home status display. This is a status-only display and the contents is user selectable.

The factory default display is shown here. It shows all eight channels plus alarm indicators. Here, the – characters indicate no alarm. The Model 9308 has nine different Home Status displays that can be viewed and selected by pressing the **Right Arrow (▶)** key.

A:	K	--
B:	K	--
C:	K	--
D:	K	--
E:	K	--
F:	K	--
G:	K	--
H:	K	--

Several displays show temperature information in a large, easy to read font. Also shown is the input channel name. This name is a convenience that allows easy association of the input channel with it's actual connection. Channel names may be entered by use of the embedded web site or via any of the remote interfaces.

A:	Sample Holder
	123.456K
B:	Rad. Shield
	234.567K

Instrument Setup Menus

The root of the instrument's setup menus is accessed by pressing the **Enter (■)** key from the Home Status display.

The Root Menu

The Root Menu displays the list of sub-menus that are used to configure the instrument.

Press the **Enter (■)** key to descend into the sub-menu, or the **Right Arrow (▶)** key to return to the Home Status display.

Selections in the root menu are as follows:

Root Menu		
1	ChA Setup	■ Press Enter to setup input channel A.
2	ChB Setup	■ Setup input channel B.
3	ChC Setup	■ Setup input channel C.
4	ChD Setup	■ Setup input channel D.
5	ChE Setup	■ Setup input channel E.
6	ChF Setup	■ Setup input channel F.
7	ChG Setup	■ Setup input channel G.
8	ChH Setup	■ Setup input channel H.
9	System Setup	■ Go to the System Setup Menu.
10	Data logging Setup	■ Configure internal data-logging.
11	Relay1 Setup	■ Configure Relay 1
12	Relay2 Setup	■ Configure Relay 2
13	Net Config	■ Go to the Network Configuration Menu.
14	Time / Date Setup	■ Setup the instrument's time and date.

Table 8: Model 9308 Root Menu

Input Channel Setup Menu

The Input Channel Setup menus are used to configure the eight input channels. They are accessed from the root menu.

The first character on each line of these menus is always the input channel identifier, which is a superscripted A, B, C, E, F, G or H.

Scrolling to a line using the **▲** or **▼** keys and then pressing the **Enter (■)** key will cause the cursor to change from a block cursor to the data entry cursor type that corresponds to the type of data that may be entered in this field.

ChA, ChB, ChC, ChD Setup Menu		
1	+ChA:Channel A	Indicates currently selected input channel. Select to scroll through all inputs.
2	+ 77.123 K	Input channel units. Temperature is displayed in real time on the left and is in the selected units. Selections are K, C, F or S. Here, S selects sensor units (Volts or Ohms).
3	+Sen:Pt100 385	Sensor type selection. Allows selection of any user or factory installed sensor.
4	+A: BiasVoltage: N/A	Selects sensor bias voltage. For NTC sensors, selections are 100mV and 10mV. All others use N/A.
5	+A: Bridge: Auto	Selects bridge range. For NTC sensors, selections are 1.0mA, 100uA, 10uA and Auto. All other sensors use Auto.
6	#High Alarm: 200.000	Set point for the High Temperature alarm.
7	+High Enable: No	High temperature alarm enable. Selections are Yes or No.
8	#Low Alarm: 200.000	Set point for the Low Temperature alarm.
9	+Low Alarm Ena: Yes	Low temperature alarm enable. Selections are Yes or No.
10	#A: Deadband: 0.250	Alarm deadband.
11	+A: Latched Enable: No	Selects latched vs. non-latched alarms.
12	A: Max: .00K	Information only. Maximum value attained since statistics reset.
13	A: Min: .00K	Information only. Minimum value attained since statistics reset.
14	A: Accum: 0.0000 Min	Information only. Time accumulated since statistics reset.
15	A: S2: 0.0000	Information only. Standard Deviation value attained since statistics reset.
16	A: M: 0.000K/Min	Information only. Slope of best-fit straight line. Value attained since statistics reset.
17	A: b: 0.000K	Information only. Offset of best-fit straight line. Value attained since statistics reset.
18	■A: Reset Statistics	Reset Statistics

Table 9: Input Channel Setup Menus.

Temperature Units

The Units field (line 1) assigns the units that are used to display temperature for the input channel. Selections are K for Kelvin, C for Celsius, F for Fahrenheit and S for sensor units. Note that if the S option is selected, the actual sensor units will be displayed when the field is deselected. Sensor units are V for Volts, m for milliVolts and Ω for Ohms.

Sensor Type Selection

Line 2 selects the Sensor type for the input channel. When this field is selected, the scroll keys are used to scroll through all of the available sensor types. Factory installed sensors appear first and then user sensors. For a list of factory installed sensors, refer to [Appendix A](#).

Setting a Temperature Alarm

The Alarm lines are used to setup alarm conditions. The Model 9308 allows alarm conditions to be assigned independently to any of the input channels.

High temperature, low temperature alarms may be entered and enabled or disabled. Note that there is a 0.25K hysteresis in the assertion of high and low temperature alarms.

The deadband field sets how much over or under the setpoint that the input temperature must be before changing the state of the alarm.

Latched or non-latched alarms may be selected. Once asserted, a latched alarm remains asserted until it is cleared.

Note: A latched alarm may be cleared by pressing the **Right Arrow (▶)** key on the front panel when the Home Status screen is displayed.

Alarm conditions are indicated on the front panel by the Alarm LED and (if enabled) an audio alarm. They are also reported via the remote interfaces.

Input Channel Statistics

Statistics are accumulated on each input channel. The accumulated values may be reset by selecting the last line of the menu: "Reset Statistics".

The System Setup Menu

The System Functions Menu is used to set many of the instrument's parameters including display resolution, I/O port settings etc. It is selected from the Root Menu.

System Functions Menu		
1	+DisplayTC: 2S	Sets the display time constant in seconds. Selections range from 0.5S to 16S
2	+DisplayRS: 3	Sets the resolution. Selections are: 1, 2, 3 or Full.
3	FW Version: 1.14D	Information Only. Firmware revision code.
4	+RS232: 9600	RS-232 serial port baud rate
5	#GPIB Adrs: 12E	GPIB address. Valid only if attached to an external GPIB option.

Table 10: System Functions Menu

Display Time Constant

The first line of the System Functions Menu is Display TC or Display Time Constant. This is an enumeration field that sets the time constant used for all temperature displays. Choices are 0.5, 1, 2, 4, 8, 16, 32 and 64 Seconds.

The time constant selected is applied to all channels and is used to smooth data in noisy environments.

Display Resolution

The Display Resolution line (Display:RS) is used to set the temperature resolution of the front panel display. Settings of 1, 2 or 3 will fix the number of digits to the right of the decimal point to the specified value. A setting of FULL will left justify the display in order to show the maximum resolution possible.

The Data-logging Setup Menu

The Data-logging Menu is used to setup internal data logging. Data accumulated into an internal buffer that may be read out by using the utility software, or by use of remote commands.

System Functions Menu		
1	+State:Off	Starts or stops data-logging.
2	#Interval: 5sec	Sets the logging interval in units of seconds.
3	Count: 0	Information Only. Number of samples logged.
4	----- --:--:--	Most recent date-time stamp.
5	■Delete Data Buffer	Clears the data-logging buffer.

Table 11: Data-logging Setup Menu

Relay Configuration Menu

The two internal relays are configured by this menu.

Relay Menu		
1	+Relay 1 Setup Menu	Starts or stops data-logging.
2	+1:Source:ChA	Sets the logging interval in units of seconds.
3	1:Src Temp:.....K	Information Only. Number of samples logged.
4	1:Rly Status:--	Information Only. Current relay status.
5	+1:Mode:Auto	Relay operating mode. Choices are Auto, ManualON and ManualOFF. Auto mode asserts or clears the relay based on the high and low setpoints along with their respective enables.
6	#1:Deadband:0.250	Deadband. Sets the amount above or below the setpoint that the input channel's temperature has to be in order to toggle the state of the relay.
7	#1:High: 200.00	High setpoint
8	+1:High Enable:No	High setpoint enable.
9	#1:Low:100.00	Low setpoint
10	+1:Low Enable:No	Low setpoint enable

The Network Configuration Menu

The Network Configuration Menu is accessed from the System Setup Menu. It is used to configure basic Ethernet LAN settings. For advanced network settings, use a web browser to view the embedded web server.

Network Configuration Menu		
1	Dev : NewSI	Information Only. Device name. May be changed by the embedded web server or a remote interface.
2	00 : 50 : C2 : 6F : 43 : 3E	Information Only. MAC address. Unique 12 digit number for each instrument.
3	+DHCP Ena : Off	DHCP enable. Recommended: Off.
4	■IP : 192 . 168 . 0 . 4	Press Enter to change the unit's Ethernet IP address.
5	■MSK : 255 . 255 . 255 . 0	Press Enter to change the unit's Ethernet subnet mask.
6	■Gwy:192.168.1.1	Press Enter to change the unit's Ethernet gateway IP.
7	#Port : 5000	TCP/IP port number. UDP port is TCP/IP port plus one.
8	>	Information Only. Displays last command received over a remote interface. Used for debugging remote programs.
9	<	Information Only. Displays last command sent over a remote interface. Used for debugging remote programs.

The Time / Date Setup Menu

The Time / Date Setup Menu is used to set the system's time and date settings.

Time / Date Setup Menu		
1	■Time : 11 : 04 : 03	System time. Press Enter to set
2	■Date : 7/1/04	System Date. Press Enter to set

Basic Operating Procedures

Configuring a Sensor

Before connecting a new sensor to the Model 9308, the instrument should be configured to support it. Most common sensors are factory installed while others require a simple configuration sequence.

Note: Sensor configuration from the instrument's front panel is discussed here. However, the process is much easier to perform by using the embedded web page.

A complete list of sensors installed at the factory is shown in [Appendix A](#). To configure the instrument for one of these sensors, proceed as follows:

1. Install the sensor on a selected input. Installation is described in the section titled [Sensor Connections](#) in Appendix H.
2. Navigate the front panel to the Input Channel Setup menu for the selected channel. The second line of this menu will show the current temperature in real-time and allow you to select the desired display units.
3. Use the navigation keys to go down to the **Sen:** field, scroll through the options and select the desired sensor. Select **None** to disable the input channel.

At the end of the factory-installed sensors, eight user-installed selections will be shown. The default name for these are User Sensor N. However, this name can be changed to give a better indication of the sensor type that is connected.

For most sensor types installation is now complete. The exceptions are NTC resistor sensors that use constant-voltage AC excitation. With these types of sensors, scroll down to the Bias Voltage field and select the desired constant-voltage excitation level. Then, select the bridge range. Default range is Auto for auto-ranged. But, some applications perform better if the actual range is fixed.

Note: Only NTC resistor sensors require the selection of a Bias Voltage and Bridge Range.

Using NTC Sensors

Negative-Temperature-Coefficient (NTC) resistors are often used as low temperature thermometers, especially at ultra-low temperature. Their resistance and sensitivity increase dramatically at low temperature but their sensitivity is often relatively poor at warmer temperatures. The Model 9308 supports these sensors by using a constant-voltage AC resistance measurement:

- Measurement accuracy and temperature range are improved at low temperature because sensor self-heating errors are reduced or eliminated.
- Measurement accuracy is improved at warmer temperatures because the constant voltage circuit increases excitation power in that region.
- The control stability is improved in the warm region since higher excitation power reduces measurement noise.
- DC offsets in the resistance bridge can cause additional power dissipation at low excitation levels. The Model 9308 holds offsets to a maximum of one-half of the minimum excitation current by use of an offset cancellation feedback loop.

Error Sources in NTC Sensor Measurements

At warm temperatures, the major source of error with NTC sensors is the measurement electronics itself. In a well designed instrument, accuracy is limited to a level established by the measurement's signal-to-noise-ratio, where the signal is the power dissipated in the sensor and noise is the collection of all noise sources. Thus, accuracy is generally improved by increasing the power dissipated in the sensor.

Conversely, at low temperature, NTC resistors have high resistance and the primary source of error is sensor self-heating caused by excitation power. The resistor has high sensitivity in this region, so measurement errors are small when viewed in units of temperature.

Constant-voltage sensor excitation increases signal power at warm temperature, thereby improving measurement accuracy in an area where the sensor is less sensitive. At low temperature, constant voltage excitation reduces the power dissipated in the sensor which reduces accuracy in units of Ohms, but more importantly, reduces sensor self-heating. Since low temperature is the sensor's most sensitive area, temperature measurement accuracy will not be degraded. The result is an accuracy improvement that extends the useful temperature range of a given sensor at both the warm and cold ends.

Voltage Bias Level Selection

The Model 9308 offers constant-voltage sensor excitation with voltage levels of 100mV and 10mV. Higher voltages improve accuracy at warm temperature and lower levels reduce self-heating at cold temperature. The user can select the best level for best accuracy over the desired temperature range.

Data Logging

The Model 9308 has an internal data logging capability that uses non-volatile memory. Logging of input channel temperature data is performed to a circular buffer that contains up to 1,000 samples. Each sample contains all eight temperature readings plus a time stamp from a real time clock.

The data logging buffer may be read by using the Utility software package. This will save the logging buffer as a text file (.CSV) that can be opened by spreadsheet and text editor programs.

Data Logging Setup

The best way to setup data logging is by using the embedded web server. However, it can also be performed from the front panel.

The first step is to ensure that the instrument's real-time clock is set to the current time. This can be done by opening the embedded web page. The current time is shown on the bottom of the [Status Page](#) and the clock may be set by going to the [System page](#).

From the front panel, the current time can be viewed and updated by going to the Time/Date Setup menu.

Data logging can be configured and enabled from the embedded web server's System page. The Logging Enable field turns logging on and off and the Interval field sets the logging sample rate. The Current Count field shows how many samples have been accumulated.

From the front panel, data logging may be configured by going to the System Setup menu and scrolling down to the Data Log Enable and Interval fields.

Once enabled, data logging will continue until stopped. When the input buffer is full, new samples will over-write the oldest samples.

Reading the Data Log Buffer

Reading, or uploading, the Model 9308 data logging buffer is best done using the Utility Software.

Launch the software and connect to the instrument. Next, click on the Data Logging menu field and then click on Upload. This will launch a series of dialog boxes that will take you through the data logging process.

<p>Note: The Utility software can perform data logging by continuously reading samples from a connected instrument. This is a different function than uploading the internal log buffer from the instrument. The internal data logging function does not require a connection to a computer.</p>

Downloading a Sensor Calibration Curve

The Model 9308 accommodates up to eight user-defined sensor calibration curves that can be used for custom or calibrated sensors. Since these curves have up to 200 entries, they are usually maintained on a computer as a text file and downloaded to the controller by using the [Utility Software](#).

Sensor calibration curves have a file extension of .crv. They may be opened and edited with any text editor. The format of the file is detailed in [Appendix A](#).

The process for downloading a sensor calibration curve using the utility software is detailed in the section titled [Downloading or Uploading a Sensor Calibration Curve](#). This section discusses how to set up a curve specifically for download to the Model 9308.

The utility software will read and attempt to parse the following file types:

Sensor Curve File Types	
SI .txt	No header information. Columns are reversed from other formats. Must be manually converted to a .crv file before use.
Lakeshore .340	Supported. Reads curve data. Header information must be entered by using the header dialog box. The utility software will convert these files into .crv format automatically.
Cryo-con .crv	Directly supported.
Other .txt	Software will attempt to parse any text file. If the file contains columns of sensor readings vs. temperature, the entries will be properly parsed and the curve can be used or converted to a .crv file after the header dialog box is filled out.

In order to download a file, run the utility software and select 'Sensor Curve Download'. The user will be prompted to select a file. Once the software has read the file, the header information dialog box will appear.

The screenshot shows a dialog box titled "Edit Curve Header:". It contains the following fields and controls:

- Sensor Name: Text input field containing "R400 RuOx 12345".
- Sensor Type: Dropdown menu showing "ACR".
- Multiplier: Text input field containing "-1".
- Unit: Dropdown menu showing "LogOhms".
- Number of Pts: Text input field containing "104".
- Buttons: "Accept", "Abort", and "Display Curve".
- Checkbox: "Save as .crv file" (unchecked).

Model 9308, 9304 and 9302 Temperature Monitors
Basic Operating Procedures

The Sensor Name can be any string, up to 15 characters, that helps identify the sensor. The Sensor Type, Multiplier and Unit fields affect how the instrument is configured, so they must be correctly set or unexpected results will be obtained.

Sensor	Type	Multiplier	Units	Example
Cernox™	ACR	-1.0	LogOhms	CX1030E1.crv
Ruthenium-Oxide	ACR	-1.0	LogOhms	LSRX102.crv
Thermistors	ACR	-1.0	LogOhms	LSRX102.crv
Rhodium-Iron 27Ω	PTC100	1.0	Ohms	rhfe27.crv
Germanium	ACR	-1.0	LogOhms	LSRX102.crv
Carbon Glass	ACR	-1.0	LogOhms	LSRX102.crv
Silicon diode	Diode	-1.0	Volts	s900diode.crv
Carbon Ceramic	ACR	-1.0	LogOhms	LSRX102.crv
Platinum 100Ω	PTC100	1.0	Ohms	PT100385.crv
Platinum 1KΩ	PTC1K	1.0	Ohms	PT1K385.crv
Platinum 10KΩ	PTC10K	1.0	Ohms	PT10K385.crv
GaAlAs diode	Diode	-1.0	Volts	s900diode.crv

Table 12: Recommended Sensor Configuration Data

Note that NTC resistor data is generally in units of LogOhms. However, it can also be in units of Ohms. Be sure to check the curve data for reasonableness.

Note: One simple way to generate a sensor calibration curve is to open a similar sensor file with a text editor and paste in your own data. The example files in the above table are for that purpose. They are located in the Model 9308 sub-directory of the utility software package.

At this point, it is a good idea to view a graph of the curve data.

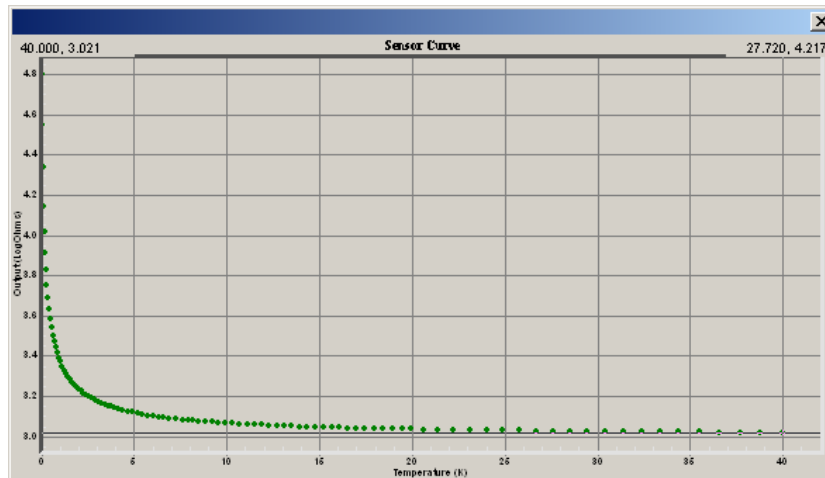

The above graph is for a Ruthenium-Oxide sensor with units of LogOhms. It shows the typical highly non-linear curve for that type sensor. If the curve data was in units of Ohms, it would be so extremely non-linear that significant errors might result.

Proceed with downloading the curve to the instrument.

Using Thermocouple Sensors

Thermocouple sensors have low sensitivity at cryogenic temperatures and are very susceptible to electrical noise. In order to obtain the best possible measurement accuracy, the recommendations given here should be carefully applied.

Installing the Thermocouple Module

All thermocouple sensors require the use of an optional external thermocouple module (120-659). This module simply plugs into any sensor input channel of a Model 9308 to support thermocouple measurements from cryogenic through oven temperatures. Up to four modules can be installed on a single instrument and they can easily be added or removed at any time. They are powered by the instrument and performs amplification, cold-junction compensation and connection to copper.

Internal switches are used to select the cold junction compensation for specific types. Open the module and use the switches to select types K, E, T, AuFe 0.7% or off.

The thermocouple device is connected to the module by using a mini-spade connector. Refer to the [Thermocouple Connections](#) section.

Gain and Offset Calibration

Thermocouple devices can vary significantly from their standard curves, especially at cryogenic temperatures where their sensitivity is reduced. To accommodate these variations, the Model 9308 allows a user calibration for individual thermocouple devices. This can be a simple offset or a two-point offset and gain calibration. Note that device calibrations do not affect the instrument's basic calibration.

Device calibration is performed by using the instrument's Input Configuration menu. Alternatively, calibration may be performed by using remote commands.

Device Offset Calibration

A simple offset, or one-point calibration is done as follows:

1. Connect the electronics as usual for thermocouple measurements. This procedure is done with the thermocouple cold-junction compensation ON. For best accuracy, be sure that ambient temperature doesn't vary.
2. From the instrument front panel, go to the input configuration menu and set the TC offset value to zero and the TC gain value to its default of 1.0.
3. Allow the instrument to warm up for at least ½ hour without moving or handling the sensor.
4. Establish the thermocouple device at a precisely known temperature. When stable, compute the TC offset by subtracting the target temperature from the instrument's reading in Kelvin or Celsius.
5. Enter the computed value into the TC offset field to complete the procedure.

Device Two-Point Calibration

Thermocouples used over an extremely wide range that includes cryogenic temperatures usually require a two-point device calibration. This will require establishment of two target temperatures.

A simple offset, or one-point calibration is done as follows:

1. Connect the electronics as usual for thermocouple measurements. This procedure is done with the thermocouple cold-junction compensation ON. For best accuracy, be sure that ambient temperature doesn't vary.
2. From the instrument front panel, go to the input configuration menu and set the TC offset value to zero and the TC gain value to its default of 1.0.
3. Allow the instrument to warm up for at least ½ hour without moving or handling the sensor.
4. Establish the thermocouple device at a precisely known high temperature and record this as the upper target temperature (Utgt). Record the instrument's reading in Kelvin or Celsius as the upper measurement temperature (Umeas).

5. Establish the device at a precisely known low temperature and record this as the lower target temperature (L_{tgt}). Record the instrument's reading in Kelvin or Celsius as the lower measurement temperature (L_{meas}).
6. Compute the TC offset as follows:

$$Offset = \frac{U_{tgt} \cdot L_{meas} - U_{meas} \cdot L_{tgt}}{L_{meas} - U_{meas}}$$

7. Compute the TC gain value as follows:

$$Gain = \frac{U_{tgt} - L_{tgt}}{U_{meas} - L_{meas}}$$

8. Enter the TC offset and TC gain values into the instrument to complete the procedure.

Check the calibration by verifying that the correct temperature is being read when the device is near the target temperature.

Grounded vs. Floating Thermocouples

Electrically floating devices are always recommended because they provide generally lower noise operation and cannot facilitate ground-loop conditions. However, the thermocouple module inputs are differential and have a high impedance to ground. This will allow operation with grounded devices in most systems. Always ensure that there is no more than a 5V difference between the grounded thermocouple and the instrument's chassis ground.

Common Error Sources

Cold Junction Compensation

Cold Junction Compensation in the thermocouple module is performed by a circuit that measures the temperature of the input connector pins. This reading is then used offset the device's output voltage. Errors can be minimized by reducing local air currents around the module.

Device Calibration Errors

Variation in the manufacture of thermocouple wire and its annealing over time can cause errors in temperature measurement.

Instruments that measure temperatures above about 0°C will usually allow the user to correct calibration errors by adjusting an offset in order to zero the error at room temperature. Unfortunately, in cryogenic applications, thermocouples lose sensitivity at low temperatures so a single offset voltage correction is insufficient.

Thermocouples used over a wide temperature range may need to be calibrated at two temperature extremes.

AC Power Line Noise Pickup

AC power noise pickup is indicated by temperature measurements that are significantly in error. In extreme cases, there may be no valid measurements at all.

When a grounded sensor is used, a poor quality ground may have sufficient AC voltage to exceed the input range of the module. This can often be corrected by running a copper connection from a point near the sensor ground and the chassis ground of the controller. Defective building wiring or insufficient grounding is usually the root cause.

General recommendations to minimize AC pickup include:

1. Minimize the length of the thermocouple wires. Connect the module as near as possible to the sensor so that thermocouple wires are converted to copper as soon as possible.
2. Twist the wires.
3. Avoid running sensor wires near, or parallel to AC power lines.

Shielding and Grounding Issues

Grounding

Power supplied to the instrument by an external supply or via Power-Over-Ethernet does not generally provide an earth ground reference. In order to minimize noise coupling into the instrument and customer's equipment, connection to an earth ground reference should be established by some other means.

Common methods include:

1. Connecting the sensor cable shield to the instrument's chassis on one end and to the cryostat ground on the other. Generally, these connections are made using the backshell on the respective connectors.
2. Connection of a ground wire from the instrument's rear panel to a ground reference. This is often the cryostat ground. Note: The enclosure, except for rear panel, is anodized and cannot make electrical connection.
3. Connection of an RS-232 cable will reference the instrument to your computer's earth ground. Connection of a LAN cable does NOT make a reference since Ethernet is isolated.
4. Ground reference the negative side of an external power supply. The supplied external power supply or a Power-Over-Ethernet supply CANNOT be ground referenced.

The Single-Point-Ground

The internal Single-Point-Ground is the voltage reference point for the instrument's grounding scheme. All circuits are designed so that no current will normally flow through the connections to this ground. Therefore, it provides a good quality, low impedance path to ground for any undesired currents that are coupled into the equipment.

Sensor Connection

For best performance, all sensors connected to the instrument should be electrically isolated (floating) from any other grounds.

Sensors used in cryogenic thermometry are often high impedance. For example, a Silicon Diode temperature sensor will have about 160K ohms of impedance at 5K. Because of this, a very efficient antenna can develop around the sensor and its connections. Requiring these sensors to be floating and providing a low impedance path to ground is the most effective way to eliminate noise pickup from this antenna effect.

To ensure that the instrument's grounding scheme is working effectively:

1. Make sure that the sensors are floating.
2. Make sure that the input cable shields are connected to the connector's metal backshell.
3. Since the Monitor's enclosure is floating, ensure that the cryostat end of the sensor cable shields are also connected to the cryostat.

Utility Software

A PC-compatible utility software package is provided with all instruments. This is available on CD, or on the Internet.

Utility software can be used to control and configure an instrument via the LAN interface. It runs under all versions of the Windows operating system. This software provides several useful functions, including:

1. Real-time strip charts of temperature.
2. Data Logging. This function allows the user to record data from the instrument at a specified sample rate. The resulting file is compatible with most spreadsheet and data analysis software.
3. Download or upload sensor calibration curves. The software will accept curves in Cryo-con .CRV, Lakeshore .340 or Scientific Instrument's .txt format. In fact, it will read almost any table of temperature vs. sensor units.
4. The CalGen[®] function is implemented. This function allows the user to fit an existing sensor calibration curve to one- two- or three user-specified points. The result is a high accuracy sensor calibration at low cost.
5. Configuration of any of the instrument's remote interfaces.
6. Flexible 'Help' interface that documents all instrument remote commands with a cut-and-paste type interface.
7. 'Interactive Mode' provides interactive communication with the instrument over any of the remote interfaces.
8. Instrument calibration using a simple step-by-step menu driven process.

Installing the Utility Software

From a CD, the utility software package does not require installation. It can be executed from the CD directly by running the UTILITY.EXE program.

When the software is downloaded off of the Internet, it is in a self-extracting ZIP format and must first be un-zipped onto hard disk.

Connecting to an Instrument

The desired remote interface connection may be selected by clicking **Comm>Port Select** from the main menu.

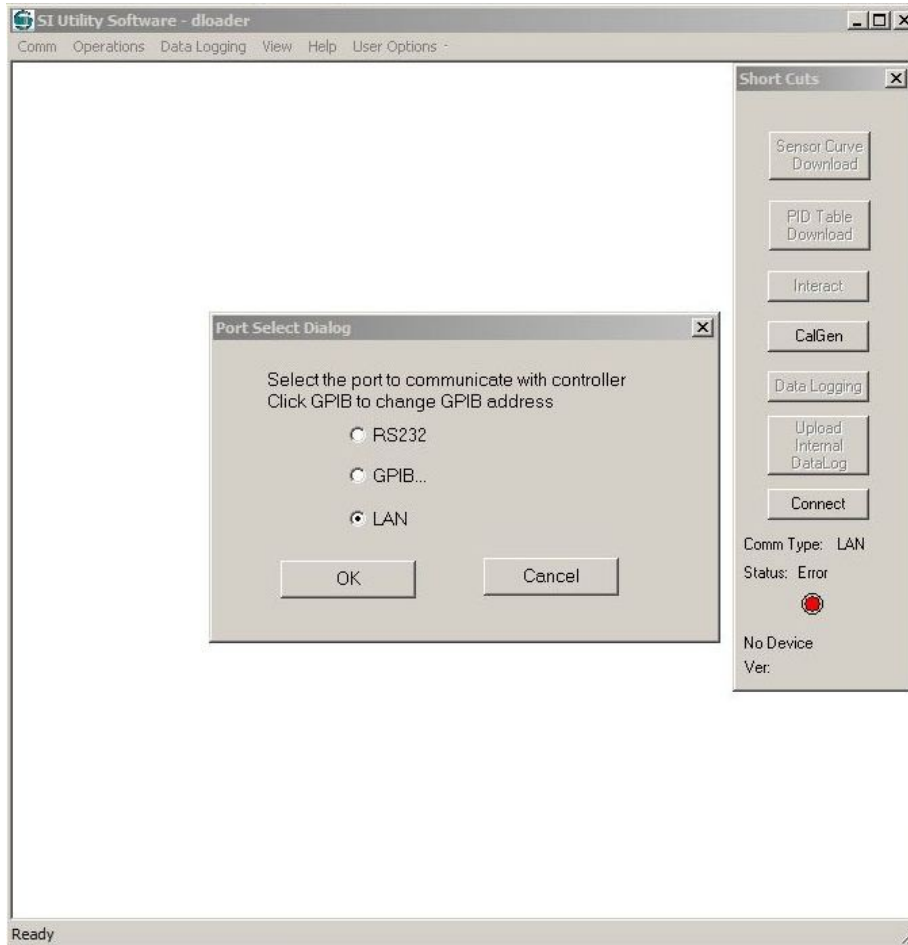

Select the desired communications port and then click **OK**..

Click on the **Connect** button of the shortcut menu bar or on **Comm->Connect** from the main menu to connect to the instrument.

After a short delay, the connect LED should light and the instrument type will be displayed. Also, most of the grayed-out fields on the menu bars should activate.

Using the Interactive Terminal

The Utility Software's Interactive Terminal mode allows the user to send commands to the instrument and view the response.

Terminal mode is selected by selecting **Comm>Interact** from the main menu or **Interact** from the shortcut bar. This will result in the display shown below.

To interact with the instrument, type a remote command into the dialog box and click **Send**. The command will be transmitted to the instrument and a response, if any, will be displayed on the background window.

To exit terminal mode, click the **Quit** button on the dialog box.

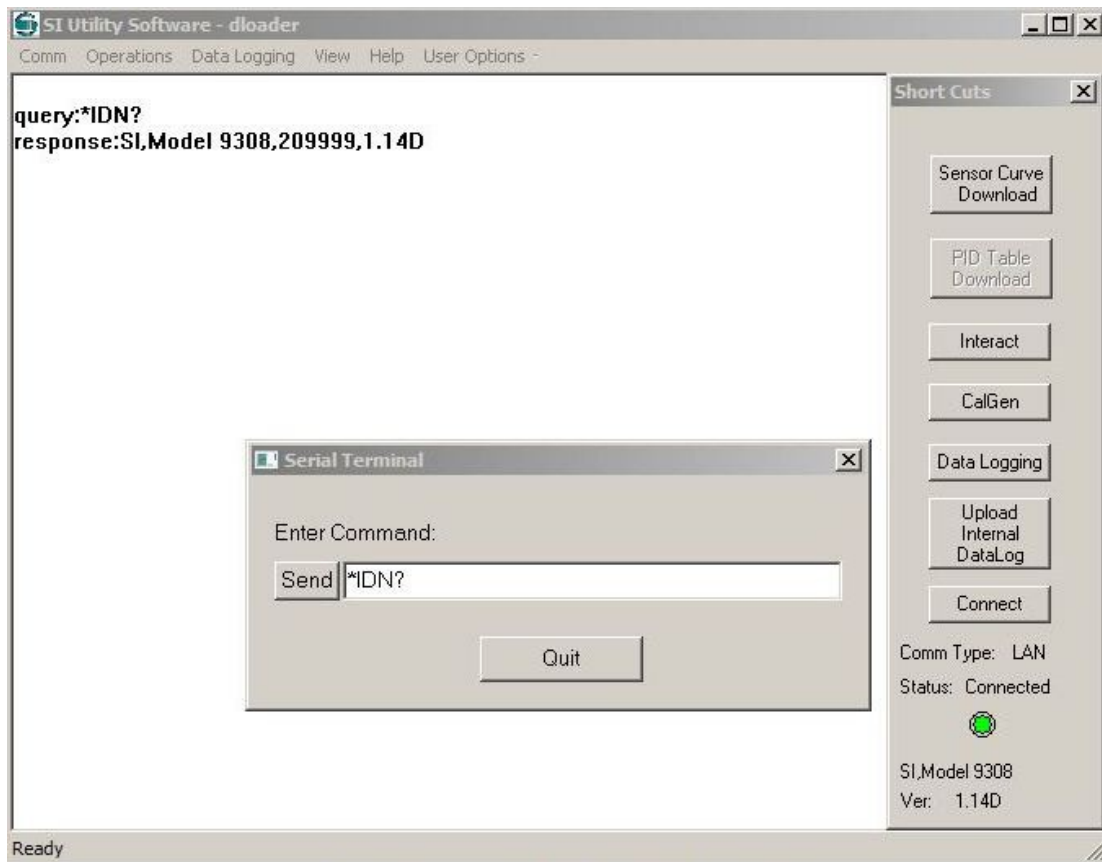

Downloading or Uploading a Sensor Calibration Curve

Sensor calibration curves may be transferred between the PC and the instrument by using the Calibration Table menu.

To download a curve (send it from the PC to the instrument), either select “Sensor Curve Download” from the shortcut bar or **Operations>Sensor Curve>Download** from the main menu. This will cause a file selection dialog box to appear as follows:

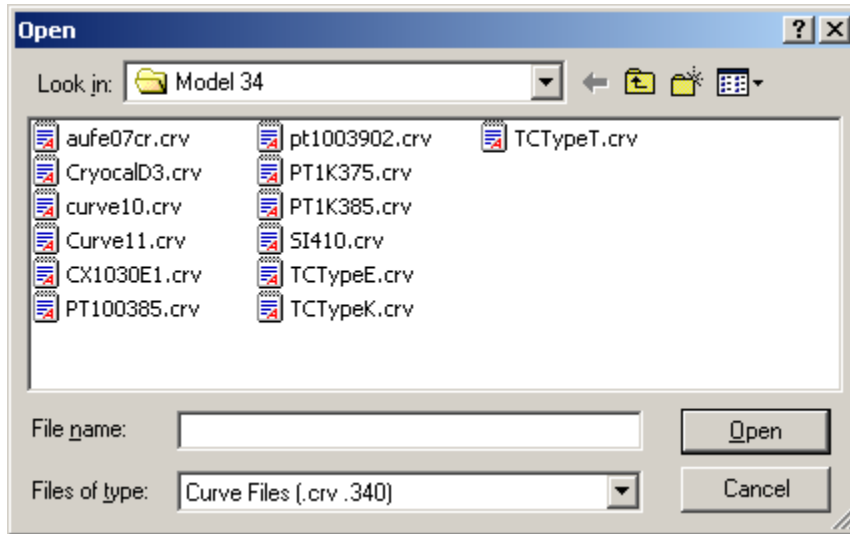

From this screen, the desired calibration curve is selected. Cryo-con calibration curves have the file extension of .CRV. Lakeshore curves with the extension .340 may also be selected. Scientific Instruments .txt files may be downloaded by first selecting a file type of *.* and then selecting the desired calibration curve file.

Cryo-con .CRV files are ASCII text files that may be edited by any text editor.

After selecting the file and clicking on **Open**, the selected file will be read and the Edit Curve Header dialog box will appear. This box contains information extracted from the curve file header that can be modified, if desired, before the curve is downloaded.

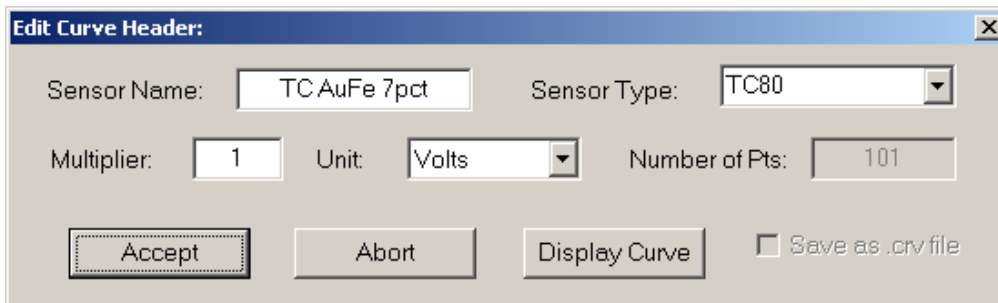

“Sensor Name” is any 15-character string and is only used to identify the sensor.

Sensor type can be selected from a pull-down menu or entered directly. Note that different models of instruments support different types of sensors. Therefore, it is important to enter a sensor type that is supported by the specific product. If the instrument receives a sensor type that it does not support, the ‘Diode’ type is selected. The section titled [“Input Configurations”](#) gives complete information on sensor types.

The Multiplier field is used to select the sign of the sensor’s temperature coefficient. A value of -1 selects a Negative-Temperature-Coefficient sensor while a value of 1 selects a Positive-Temperature-Coefficient.

The Unit field selects the units used in the calibration curve. Choices are: Volts, Ohms or LogOhm.

Checking the 'Save as .crv' will save the curve to disk as a .crv file.

The sensor curve may be viewed as a graph by clicking the 'Display Curve' button. An example plot is shown here:

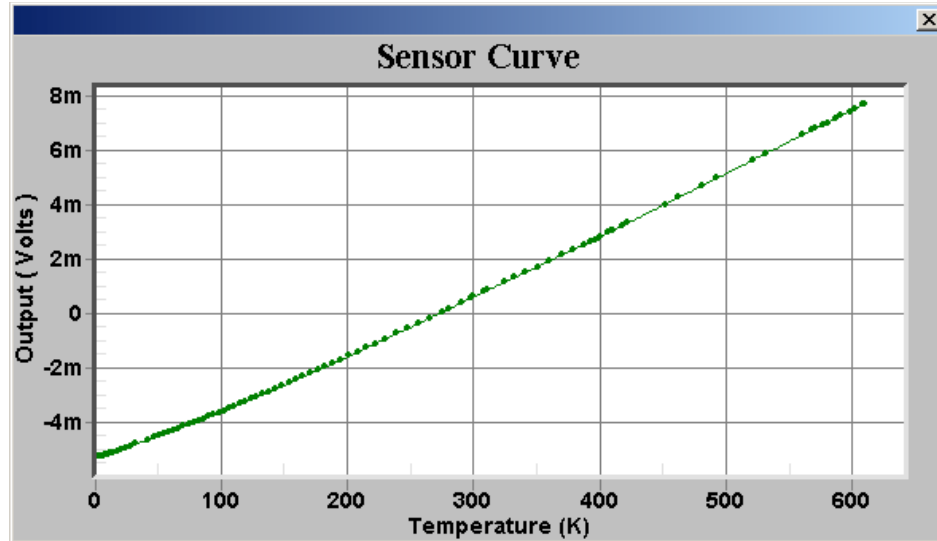

After completing any desired changes in the "Edit Curve Header" dialog box, click 'Accept' to proceed. Then the, curve number dialog box will appear:

A user calibration curve should be entered here. For the Model 9308, user curves are 1 through 8.

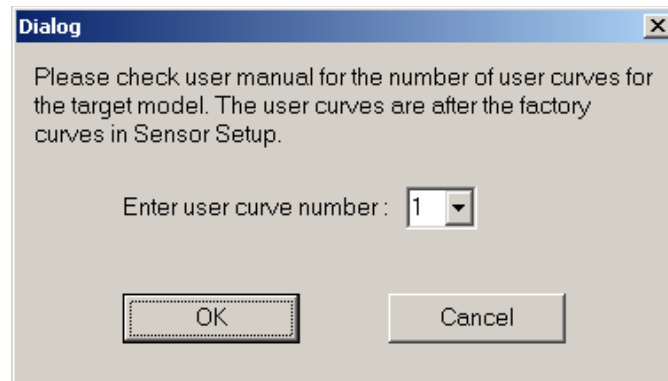

Model 9308, 9304 and 9302 Temperature Monitors
Utility Software

When 'OK' is selected, the sensor calibration curve will be downloaded to the instrument. During the transfer, curve data points will be displayed in the window's main pane. Upon completion, the Download Complete dialog box will appear:

Dismiss this dialog box to complete the download process.

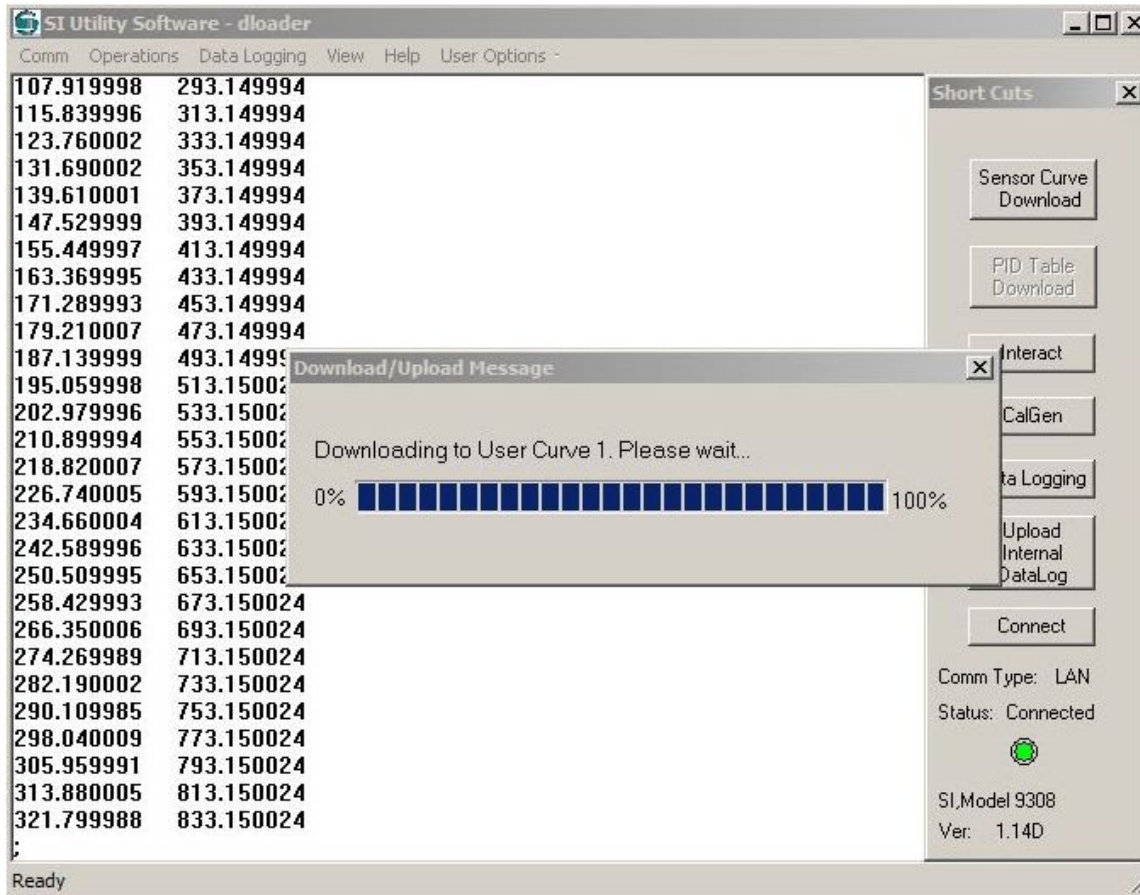

To upload a calibration curve, use the same procedure and select **Upload**. This will transfer a curve from the instrument to the PC.

Using the Real-Time Strip Charts

The real-time strip chart feature of the Utility Software lets the user continuously display any combination of input channels on the computer display.

This function is initiated by selecting the **View** command on the Utility Software's main toolbar, then selecting the desired channels to monitor.

A strip chart will be displayed for each channel selected. The dialog box will show the channel's Input Identifier, Name String and a chart of current temperature.

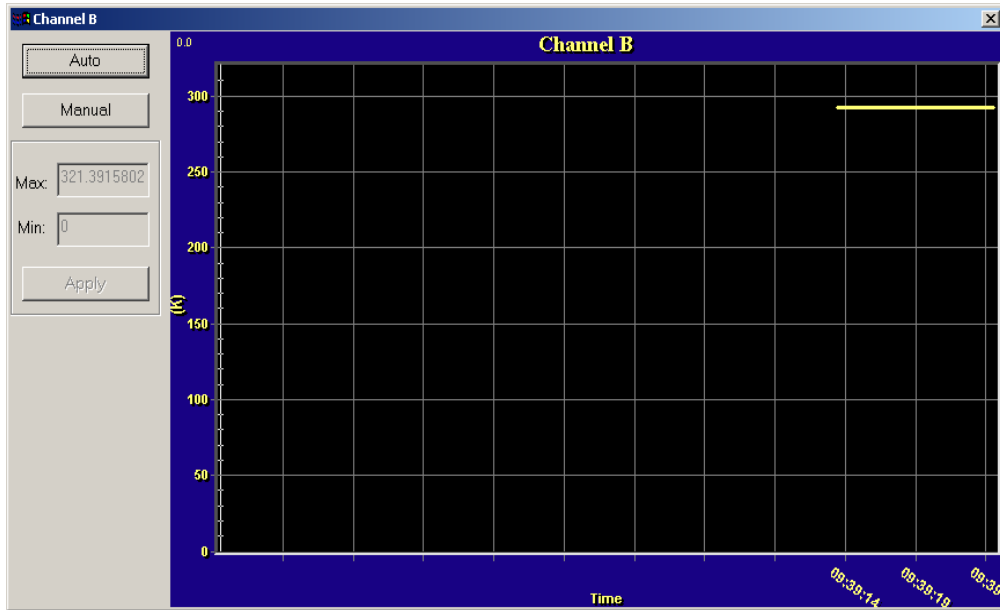

The update rate of the chart is locked to the program's Data Logging Interval. The section below details how to set this value.

Data Logging

The Utility Software will perform data logging on all of the instruments input and control output channels. The result is a disk file in Comma-Separated-Value, or CSV format. This format is compatible with any data analysis or charting software including Microsoft Excel.

To initiate data logging, select the **Data Logging** button from the Utility Software's main menu. The Data Logging Setup dialog box will now appear.

On this dialog box, check the desired channels and set an Interval value in Seconds. The minimum interval is 0.1 Second.

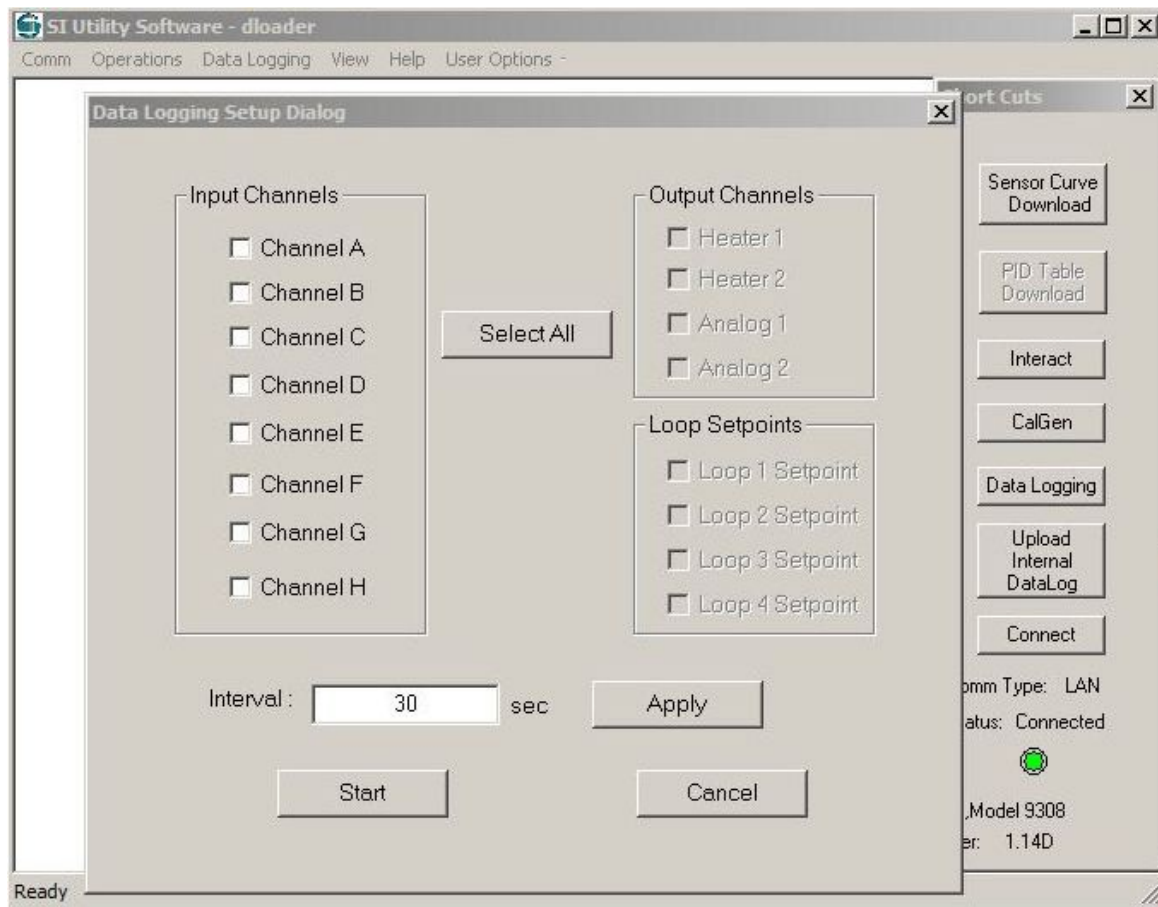

When the **Start** button is clicked, a file selection dialog box will be shown.

From this dialog box, enter a file name and select the directory where data logging results will be saved.

Model 9308, 9304 and 9302 Temperature Monitors
Utility Software

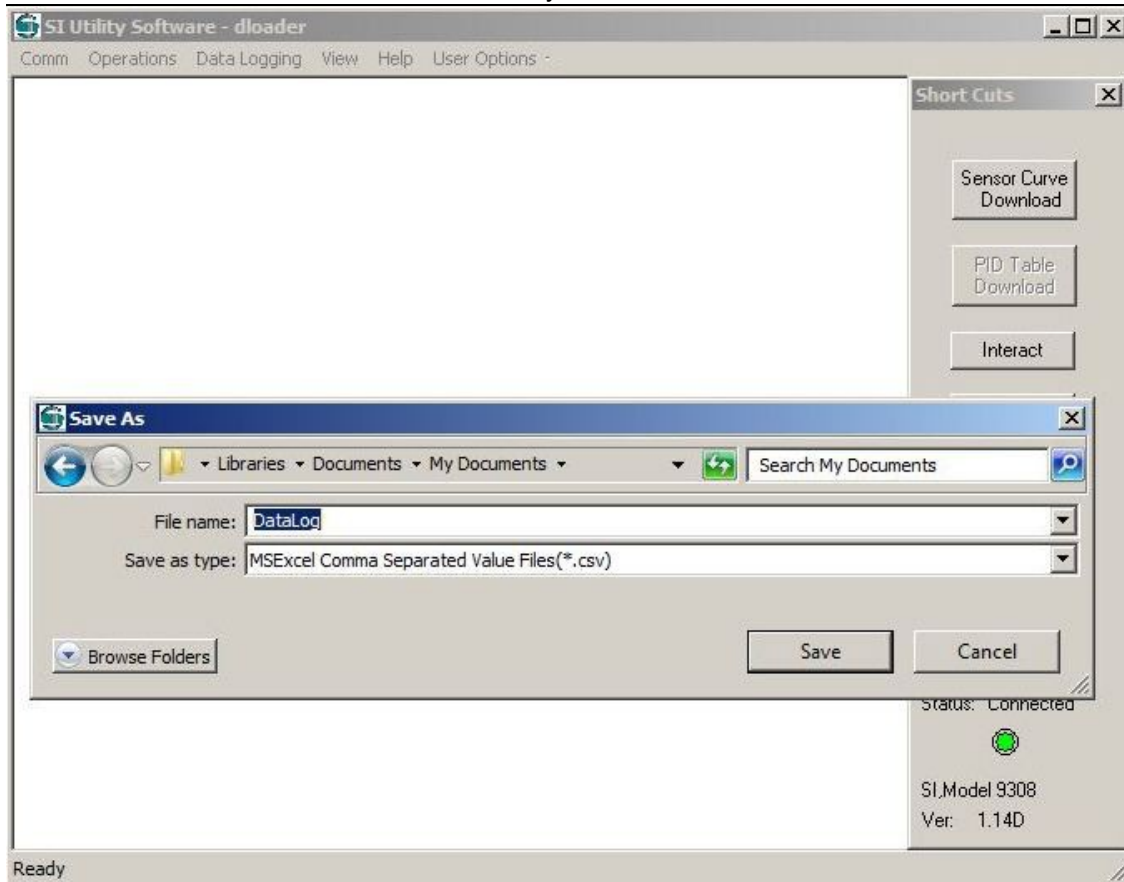

As soon as the **Save** button is clicked, the software will begin continuous data logging to the specified file. While data logging is in progress, a dialog box will be displayed that allows the user to stop logging. When this **Stop** button is clicked, logging is stopped and the log file is closed.

CalGen Calibration Curve Generator.

The CalGen feature is used to generate new calibration curves for Silicon diode or resistor sensors. This provides a method for obtaining higher accuracy temperature measurements without expensive sensor calibrations.

Curves can be generated from any user selected sensor calibration curve and are written to a specified internal user curve location.

For diode sensors, the user may specify one, two or three data points. CalGen will generate the new curve based on fitting the input curve to the user specified points.

Platinum or other resistor calibration curves require one or two data points. The generated curve will be a best fit of the input curve to the two specified input points.

Since CalGen fits a sensor calibration curve to measured data, any errors in the instrument's measurement electronics are also effectively canceled.

CalGen Initial Setup

To start the CalGen process, either select **CalGen** from the shortcut bar, or select Operations>CalGen from the main menu. This initiates the process of generating a new sensor curve.

Using CalGen With Diode Sensors

Options for generating diode calibration curves are:

1. One point near 300K. The portion of a diode Sensor curve above 30K is fit to a user-specified point near 300K. This is a two-point fit where the 30K point is taken from the existing calibration curve. The portion of the curve below 30K is unaffected.
2. Two points: 300K and 77K. These two user-specified points are taken to fit the diode curve region above 30K. The entire curve is offset to match the 77K point, then, the >30K region is fit to the two points.
3. Three points: 300K, 77K and 4.2K. Two points above 30K are fit as in the selection above. Then, a third point is used to fit a single point in the high-sensitivity region below 20K.
4. One point near 4.2K. This is a two-point fit where the 20K point is taken from the existing calibration curve. The portion of the curve above 20K is unaffected.

Using CalGen With Resistor Sensors

The calibration curve generation procedure for Platinum or other resistor sensors is the same as for the diode. However, these sensor curves are generated using two user specified points. Therefore, the selection of the number of points is not required.

Example CalGen Procedure

A complete procedure for calibrating a diode sensor at three points is shown here. Before the procedure can be started, the instrument must be connected and have a valid sensor connected.

The CalGen procedure requires the user to stabilize the input temperature at three user-selected points. It will capture data at each of these points and then generate a new curve from that data.

When a 3-point CalGen is started for a Silicon diode sensor, the reference curve must first be selected. This is the curve that will be rotated and shifted to fit the selected points.

When the curve has been selected, the following dialog box will appear:

The dialog box is titled "Enter three reference points" and contains three sections for entering reference points. Each section has a label, a "Temperature:" field, and a "Voltage:" field. The labels are "Enter a reference point close to 4.2K", "Enter a reference point close to 77K", and "Enter a reference point close to 300K". The "Temperature:" and "Voltage:" fields each contain the number "0". At the bottom of the dialog box are three buttons: "OK", "Cancel", and "Vapor Pressure".

The process requires the user to completely fill out this dialog box by selecting a temperature and then copying the voltage (or resistance) reading corresponding to that temperature from the instrument.

Note that the Vapor Pressure button takes the user to a convenient calculator that computes the temperature of various cryogens from the current barometric pressure.

Once the dialog box has been completed, click OK to proceed.

To finish the process, a prompt will require the user to save the modified calibration curve to a file. Once complete, the file can be transferred to an instrument.

Instrument Calibration

Calibration of the Model 9308 requires the use of various voltage and resistance standards in order to generate calibration factors for the many measurement ranges available.

Calibration is 'Closed-Case'. There are no internal mechanical adjustments required. The Model 9308 cannot be calibrated from the front panel.

Calibration data is stored in the instrument's non-volatile memory and is accessed only via the remote interfaces. Calibration of a measurement range is the simple process of generating an offset and gain value. However, since there are several input ranges available on each sensor input, the process can be time consuming.



Caution: Any calibration procedure will require the adjustment of internal data that can significantly affect the accuracy of the instrument. Failure to completely follow the instructions in this chapter may result in degraded instrument performance. The utility software used in this procedure will first read all calibration data out of the instrument before any modifications. It is good practice to record these values for future reference and backup.

Calibration Services

When the instrument is due for calibration, contact Scientific Instruments for low-cost recalibration. The Model 9308 is supported on our automated calibration systems which allow us to provide this service at competitive prices.

Calibration Interval

The Model 9308 should be calibrated on a regular interval determined by the measurement accuracy requirements of your application.

A 90-day interval is recommended for the most demanding applications, while a 1-year or 2-year interval may be adequate for less demanding applications. SI does not recommend extending calibration intervals beyond 2 years.

Whatever calibration interval you select, SI recommends that complete re-adjustment should always be performed at the calibration interval. This will increase your confidence that the instrument will remain within specification for the next calibration interval. This criterion for re-adjustment provides the best measure of the instrument's long-term stability. Performance data measured using this method can easily be used to extend future calibration intervals.

Minimum Required Equipment

All calibrations require a computer with a LAN connection to the instrument. Additionally, reference standards are required for each input range as follows:

- The Silicon Diode input range (Calibration Type I10UA and V10UA) requires voltage references of 0.5 and 1.5 Volts DC and a resistance standard of 100K Ω
- The 100 Ω Platinum range (Type R1MA) requires a 100 Ω and a 10 Ω resistor.
- The 10,000 Ω range (Type R10UA) requires 10K Ω and 1K Ω resistors.

The test equipment recommended for complete calibration is a Fluke 5700A DMM calibrator.

The Basic Calibration Sequence

You must first connect the Model 9308 to a computer via the LAN interface and then run the Utility Software provided with the instrument. The Utility Software must be version 11.0.0 or higher.

From the start-up menu of the Utility Software, click the Connect button in the bottom of the Short Cuts toolbar. The software will connect to the instrument and display the connection status below the button.

To manually calibrate a range, select the desired range from the range type tabs and enter the desired Gain and Offset values in the boxes given and then, click the **APPLY** button.

Gain is a unit-less gain factor that is scaled to a nominal value of 1.0. It is usually computed by:

$$\text{gain} = (\text{UT} - \text{LT}) / (\text{UM} - \text{LM})$$

where:

UT is the upper target and LT is the lower target.

UM is the upper measurement and LM is the lower measurement.

Gain values greater than 1.2 or less than 0.8 are rejected as out of range.

Offset is in units of Volts or Ohms depending on the calibration type. Nominal value is 0.0. Positive or negative numbers are accepted. It is usually calculated by:

$$\text{Offset} = \text{UT} - \text{gain} * \text{UM}$$

Summary of Calibration Types

Calibration data must be generated for each input channel by sequencing through the various calibration types on each channel. A summary of types is given here:

Calibration Type	Voltage Range	Output Current	Description
SI DiodeV	0 – 2.2V	N/A	Voltage measurement for use with Silicon diode temperature sensors.
SI Diode I	N/A	10 μ A	10 μ A constant-current source used with Silicon diode sensors.
1mA AC	10mV, 1.25Hz	1.0mA	1mA range used with constant-voltage mode sensors.
100μA AC	10mV, 1.25Hz	100 μ A	100 μ A range used with constant-voltage mode sensors.
10μA AC	10mV, 1.25Hz	10 μ A	10 μ A range used with constant-voltage mode sensors.
1mA DC	0-2.5VDC	1.0mA	DC measurement of 100 Platinum RTD sensors.
100μA DC	0-2.5VDC	100 μ A	DC measurement of 1K Ohm Platinum RTDs
10μA DC	0-2.5VDC	10 μ A	DC measurement of 10K Ohm Platinum RTDs or other resistor sensors that use DC current excitation

Calibration of Silicon Diodes

Silicon Diode sensors require the application of a precision 10 μ A current followed by reading the voltage-drop across the device. Therefore, calibration of a diode requires two steps: 1) Calibration of the input voltage reading and 2) Calibration of the 10 μ A current source.

Note that the voltage calibration must always be done first since the current source calibration requires a precision voltage reading.

Diode Voltage Calibration

To calibrate the diode voltage range, click on the **SI Diode V** tab and follow the sequence described above to send Gain and Offset values to the instrument.

The upper target requires connection of a 1.9 Volt source. The actual value is between 1.0 Volts and 2.4 Volts. If you do not have a precision voltage source, you can use a 1.5 Volt battery by using a high precision volt meter to measure it's actual voltage.

The lower target requires connection of a 0.5 Volt source. The actual value is between zero Volts and 0.6 Volts. If you do not have a precision voltage source, you can short the input channel for zero volts.

Constant-current Source Calibration

Calibration of the constant-current source is performed by using the **SI Diode I** tab. On this screen, only an upper target value is required since the current-source only requires a gain term.

The upper target requires connection of a 100K Ω resistor. The actual value should be within 10% of 100K Ω .

Calibration of DC resistors

Resistor sensors that use direct current excitation are calibrated by using the **1mA DC**, **100uA DC** and **10uA DC** tabs.

Resistors required for calibration are as follows:

- 1mA DC:** Upper - 100 Ω , Lower - 10 Ω .
- 100uA DC:** Upper 1,000 Ω , Lower - 100 Ω
- 10uA DC:** Upper - 10,000 Ω , Lower - 1,000 Ω

Remote Operation

Remote Interface Configuration

The Model 9308 has two remote interfaces: The 10/100-BaseT Ethernet LAN and the RS-232. There are also two external options: IEEE-488.2 (GPIB) and USB. Connection to all of these interfaces is made on the rear panel of the instrument. For specifics about the connectors and cables required, refer to the section on Rear Panel Connections.

Supported Ethernet Protocols

HTTP: The Model 9308's HTTP server is used to implement the instrument's embedded web server. Up to five connections are supported simultaneously and connections are automatically closed after five minutes of inactivity.

SMTP: The Simple Mail Transport Protocol is used to send E-mail from the Model 9308 to a selected address. E-mail is used to report instrument status and is triggered by various user selected events. If sending e-mail over the Internet is desired, the local area network connected to the Model 9308 will have to have an active mail server.

TIMEP: The Time Protocol allows a client to obtain the date and time from a host TIMEP server. If a time server is available on the Local Area Network, the Model 9308 will periodically query it to update it's internal real-time clock.

TCP/IP: The Transmission Control Protocol / Internet Protocol provides reliable, flow-controlled, end-to-end, communication between two connected devices. TCP operates even if packets are delayed, duplicated, lost, delivered out of order, or delivered with corrupted or truncated data.

UDP: The User Datagram Protocol implemented on the Model 9308 is similar to TCP but is connectionless. Since a connection does not need to be negotiated or maintained, UDP has a much lower overhead than TCP/IP.

In the Model 9308, a TCP/IP port is available for communication using an ASCII command language. This is how the instrument interfaces some data acquisition software packages, including LabView™. Where the user is implementing custom software, UDP is recommended because of it's lower overhead.

Ethernet Configuration

Each device on an Ethernet Local Area Network must have a unique IP Address. This is similar to IEEE-488 systems where each device required a unique 'GPIB' address. Further, the address assigned to the Model 9308 must be within the range of the computers you want it to communicate with. The range is determined by the Subnet Mask.

To connect to a LAN switch or hub, use a standard Category 5 patch cable. To connect directly to a PC, use a Category 5 crossover type patch cable.

The Model 9308 is shipped with a default IP address of **192.168.1.4** and Subnet Mask of **255.255.255.0**. Using these settings, the instrument communicates with any computer or device that has an IP addresses in the range of 192.168.1.0 through 192.168.1.255. The user can configure the Model 9308 to use any other IP address by going to the [Network Configuration Menu](#).

UDP Configuration

UDP is a simple connection-less protocol that can be used to communicate with instruments. The user binds a UDP socket and communicates with the instrument in a fashion similar to the older RS-232 style communications.

Before you can bind a UDP socket, you will need to know the instrument's IP address and port number. Both the IP and port number may be obtained from the front panel of the instrument or by using the discovery function of the utility software.

UDP uses a port that is the TCP port address plus one. The factory default is 5001.

TCP/IP Data Socket Configuration

TCP/IP is a connection orientated protocol that is more complex and has higher overhead than UDP. The user must bind a TCP/IP socket and negotiate a connection before communicating with an instrument.

Before you can bind a TCP/IP socket, you will need to know the instrument's IP address and port number. Both may be obtained from the front panel of the instrument or by using the discovery function of the utility software.

The default TCP/IP port address is 5000. This can be changed from the front panel by going to the [Network Configuration Menu](#). The Model 9308 will handle up to five TCP/IP connections simultaneously. Connections will be automatically closed after 5 minutes of inactivity.

Checking the TCP/IP connection with Hyperterminal

Hyperterminal, or any other TCP/IP communications program can be easily used to test the TCP/IP connection. Run the program and configure it with the IP (default: 192.168.1.4) and TCP/IP port (Default: 5000) and it should be possible to type in basic commands. For example:

```
*IDN?  
should return:  
SI,Model 9308,204683,1.01A
```

When working with the TCP/IP interface, it is often convenient to go to the [Network Configuration Menu](#). The bottom two lines of this screen show the last line received and sent by the instrument.

Web site configuration

The Model 9308 factory default settings are as follows:

```
IP address: 192.168.1.4  
Subnet Mask: 255.255.255.0  
Gateway: 192.168.0.1  
TCP Data Socket: 5000, UDP Data Socket: 5001  
DHCP: OFF
```

These settings are also entered into the Model 9308 when the LAN Reset sequence is executed from the front panel.

The instrument's embedded web site may be opened in any web browser by typing **http://192.168.1.4** into the address bar, and the Model 9308's Home Page should appear. Alternatively, if the network system has a DNS server, use the instrument's name instead of the IP address. The default name is: M9308xxxx where xxxx is the last four digits of the instrument's serial number.

From the Model 9308's web page, configure the instrument to meet the network requirements.

IEEE-488 (GPIB) Option Configuration

The only configuration parameter for the optional GPIB interface is to set the address. This is done by using the [System Functions Menu](#) described above. Once the external GPIB interface is connected to the controller's LAN port, configuration is performed by the instrument.

Note that each device on the GPIB interface must have a unique address. Set the instrument's address to any value between 1 and 31. The address is set to 12 when the unit is shipped from the factory.

The GPIB interface does not use a termination character, or EOS. Rather, it uses the EOI hardware handshake method to signal the end of a line. Therefore, the host must be configured to talk to the instrument using EOI and no EOS.

Primary Address:	1-31
Secondary Address:	None
Timeout	2S
Terminate Read on EOS	NO
Set EOI with EOS on Writes	YES
EOS byte	N/A

Table 13: GPIB Host Setup Parameters

RS-232 Configuration

The user can select RS-232 Baud Rates between 300 and 38,400. The factory default is 9600.

The Baud Rate is changeable from the instrument's front panel by using the [System Functions Menu](#).

Other RS-232 communications parameters are fixed in the instrument. They are set as follows:

Parity: None
Bits: 8
Stop Bits: 1
Mode: Half Duplex

The RS-232 interface uses a "New Line", or Line Feed character as a line termination. In the C programming language, this character is \n or hexadecimal 0xA.

When sending strings to the controller, any combination of the following characters must be sent to terminate the line: a) Carriage Return. b) Line Feed. c) Null.

The controller will always return the \n character at the end of each line.

<p>Note: Some serial port software drivers allow the programmer to set a line termination character. This character is then appended to each string sent to the controller and stripped from returned strings. In this case, the \n (0xA) character should be selected.</p>
--

Checking the RS-232 connection with Hyperterminal

Hyperterminal, or any other RS-232 communications program can be easily used to test the connection. Run the program and configure it with instrument's serial configuration in order to type in basic commands. For example:

```
*IDN?  
should return:  
SI,Model 9308,204683,1.01A
```

When working with the the RS-232 interface, it is convenient to go to the [Network Configuration Menu](#). The bottom two lines of this screen show the last line received and sent by the instrument.

USB option configuration

The external USB option is automatically configured by the instrument when it is plugged into the RS-232 port. Your computer will see it as an extra COM port. Use it for communications just like any other RS-232 port.

Remote Programming Guide

General Overview

This brief is intended to assist the user interested in remote programming of an instrument. The remote interface language is common to all multichannel monitor products.

Since the language supports both simple and advanced functions, it may initially seem complex. However, the use of English language keywords and a tree-structured architecture make it easy to read and learn.

Language Architecture

The programming language used by the instruments is described as follows:

- The industry standard SCPI language defined by the IEEE-488.2 standard is used. Therefore, anyone with experience in test and measurement will find it familiar.
- All monitor instruments use the same language and future instruments will continue in the same fashion. Therefore, your investment in system software will not be lost when a product is revised or obsoleted.
- Keywords used in commands are common English words, not cryptic acronyms. This makes command lines easy to read and understand, even for someone that is not familiar with the instrument.
- The SCPI is a 'tree structured' language where commands are divided into groups and associated commands into sub-groups. This architecture simplifies composing commands and improves readability.

Purpose

If your intent is to remotely program an instrument with fairly simple sequences, you can skip to the section titled "[Commonly Used Commands](#)". This is a simple cheat-sheet format list of the commands that are most frequently used.

If you are an advanced user with a familiarity of the SCPI programming language, the section titled "[Remote Command Descriptions](#)" is a complete reference to all commands.

If you are not familiar with the SCPI language but need to perform advanced programming tasks, the SCPI is introduced in the next section.

For all users, the section titled "[Debugging Tips](#)" is often helpful and the "[Remote Command Tree](#)" is a single page listing that shows the syntax of each command.

An Introduction to the SCPI Language

SCPI is an acronym for **Standard Commands for Programmable Instruments**. Commonly called 'skippy', it is an ASCII-based instrument command language defined by the IEEE-488.2 specification and is commonly used by test and measurement instruments.

SCPI commands are based on a hierarchical structure, also known as a tree system. In this system, associated commands are grouped together under a common node or root, thus forming subsystems. A portion the command tree for an instrument is shown here:

INPut	SYSTem
TEMPerature	BEEP
UNITs	ADRS
VARlance	LOCKout
SLOPe	
ALARm	
NAME	
LOOP	CONFIg
SETPT	SAVE
RANGe	RESTore
RATE	

In the above, INPut and LOOP are root keywords whereas UNITs and RATE are second-level keywords. A *colon (:)* separates a command keyword from lower-level keyword.

Command Format

The format used to show commands is shown here:

```
INPut {A | B | C | D}:ALARm:HIGH <value>;  
      NAME "name";
```

The command language is case-insensitive, but commands are shown here as a mixture of upper and lower case letters. The upper-case letters indicate the abbreviated spelling for the command. For shorter program lines, send the abbreviated form. For better program readability, send the long form.

For example, in the above statement, INP and INPUT are both acceptable.

Braces ({ }) enclose the parameter choices for a given command string. The braces are not sent as part of the command string.

A *vertical bar (|)* separates multiple parameter choices for a given command string.

Triangle brackets (< >) indicate that you must specify a numeric value for the enclosed parameter.

Double-quote (") marks must enclose string parameters.

Commands are terminated using a semicolon (;) character. The semicolon at the end of the line is assumed and is optional.

The { }, |, <> and " characters are for the illustration of the command syntax and not part of the command syntax.

Command Separators

A *colon (:)* is used to separate a command keyword from a lower-level keyword. You must insert a *blank space* to separate a parameter from a command keyword.

Compound Commands

A semicolon (;) is used as a terminator character that separates commands within the same subsystem. For example, sending the following command string:

```
INPut A:UNITs K;TEMPer?;
```

has the same effect as sending the following two commands:

```
INPut A:UNITs K;  
INPut A:TEMPer?;
```

If multiple commands address different subsystems, the combination of a semicolon (;) and a colon (:) are used. The semi-colon terminates the previous command and the colon indicates that the next command is in a different subsystem. For example:

```
INPut A:TEMPer?;:LOOP 1:SETPt 123.45;
```

has the effect of sending the following two commands:

```
INPut A:TEMPer?;  
LOOP 1:SETPt 123.45;
```

Queries

You can query the current value of most parameters by adding a question mark (?) to the command. For example, the following command set the setpoint on control loop 1 to 123.45:

```
LOOP 1:SETPt 123.45;
```

You can change it into a query that reads the setpoint by using the following:

```
LOOP 1:SETPt?;
```

The instrument's response will be a numeric string such as: 123.45.

Compound queries are commonly used to save programming steps. For example, the query:

```
LOOP 1:SETPt?;PGAin?;IGAin?;DGAin?;
```

reports the loop 1 setpoint, P-gain, I-gain and D-gain. An example response is:

```
123.45;20.0;60;12.5;
```

Note that the response is also separated by semicolons.

The representation of the decimal symbol for floating point numbers must be a period, '.', instead of comma, ',' as is customary used in some European countries.

Command Terminators

The termination of a command line is determined by the type of interface being used.

SCPI Common Commands

The IEEE-488.2 SCPI standard defines a set of common commands that perform basic functions like reset, self-test and status reporting. Note that they are called common commands because they must be common to all SCPI compliant instruments, not because they are commonly used.

Common commands always begin with an asterisk (*), are four to five characters in length and may include one or more parameters. Examples are:

```
*IDN?  
*CLS  
*OPC?
```

SCPI Parameter Types

The SCPI language defines several different data formats to be used in program messages and response messages.

Numeric Parameters: Commands that require numeric parameters will accept all commonly used decimal representations of numbers including optional signs, decimal points and scientific notation.

Enumeration Parameters: These are used to set values that have a limited number of choices. Query responses will always return an enumeration parameter in upper-case letters. Some examples of commands with enumeration parameters are:

```
INPut {A | B | C | D}:UNITs {K | C | F | S}  
LOOP {1 | 2}:TYPE {OFF | MAN | PID | TABLE | RAMPP}
```

String Parameters: String parameters can be up to 15 characters in length and can contain any ASCII characters excluding the double-quote ("). String parameters must be enclosed in double-quotes ("). For example:

CONFig 4:NAME "Co1d Plate"

Commonly Used Commands.

A complete summary of remote commands is given in the User's Manual chapter titled "Remote Command Summary". The manual also has complete descriptions of all remote commands. This section is intended to show a few of the more commonly used commands.

① **NOTE:** Remote commands are not case sensitive.

Function	Command	Comment
Instrument Identification		
Read the instrument identification string	*idn?	Returns the instrument identification string in IEEE-488.2 format. For example: "SI,Model 9308,204683,2.41" identifies the manufacturer followed by the model name, serial number and firmware revision code.
Input Channel Commands Parameter for the input is A, B, C or D corresponding to inputs A, B, C or D.		
Read the temperature on input channel B	input? b	Temperature is returned in the current display units. Format is a numeric string. For example: 123.4567
Set the temperature units on input channel A to Kelvin.	input a:units k	Choices are K- Kelvin, C- Celsius, F- Fahrenheit and S- native sensor units (Volts or Ohms).
Read the temperature units on channel B	input b:units?	Return is: K, C, F or S.

Table 14: Commonly Used Remote Commands

Debugging Tips

1. To view the last command that the instrument received and the last response it generated, press the System key and then select the Network Configuration Menu. The last two lines of this menu show > and < characters. These two lines show the last command received by the instrument and the last response generated.
2. Some commands require the instrument to write to non-volatile flash type memory, which can be time consuming. In order to avoid overrunning the instrument use compound commands that return a value, thus indicating that command processing is complete. For example:
INPUT A:UNITS K;UNITS?
will respond with the input units only after the command has completed. Another example:
LOOP 1:SETPOINT 1234.5;:*OPC?
Here, the operation complete command :*OPC? will return a '1' when command processing is complete.
3. It is often easiest to test commands by using the utility software. Run the program, connect to the instrument and use the Interact mode to send commands and view the response. Alternatively, any communications program like Windows Hyperterminal can be used to interact with the instrument via the LAN or serial ports.
4. For ease of software development, keywords in all SCPI commands may be shortened. The short form of a keyword is the first four characters of the word, except if the last character is a vowel. If so, the truncated form is the first three characters of the word. Some examples are: inp for input, syst for system alar for alarm etc.

SCPI Status Registers

The Instrument Status Register

The Instrument Status Register (ISR) is queried using the SYSTEM:ISR? command.

The ISR is commonly used to generate a service request when various status conditions occur. In this case, the ISR is masked with the Instrument Status Enable (ISE) register.

The ISR is defined as follows:

ISR

Bit7	Bit6	Bit5	Bit4	Bit3	Bit2	Bit1	Bit0
Alarm						SFB	SFA

Where:

Bit7 – Alarm: Indicates that an alarm condition is asserted. Use the ALARM commands to query individual alarms.

Bit1 to Bit0 – SFx: Indicates that a sensor fault condition is asserted on an input channel. Use the INPUT commands to query the input channels.

The Instrument Status Enable Register

The Instrument Status Enable (ISE) Register is a mask register. It is logically “anded” with the contents of the ISR in order to set the Instrument Event (IE) bit in the Status Byte (STB) register. This can cause a service request to occur.

Bits in the ISE correspond to the bits in the ISR defined above.

The Standard Event Register

The Standard Event Register (ESR) is defined by the SCPI to identify various standard events and error conditions. It is queried using the Common Command *ESR? This register is often used to generate an interrupt packet, or service request when various I/O errors occur.

Bits in the ESR are defined as follows:

ESR

Bit7	Bit6	Bit5	Bit4	Bit3	Bit2	Bit1	Bit0
OPC		QE	DE	EE	CE		PWR

Where:

Bit7 – OPC: Indicates Operation Complete.

Bit5 – QE: Indicates a Query Error. This bit is set when a syntax error has occurred on a remote query. It is often used for debugging.

Bit4 – DE: Indicates a Device Error.

Bit3 – EE: Indicates an Execution Error. This bit is set when a valid command was received, but could not be executed. An example is attempting to edit a factory supplied calibration table.

Bit2 – CE: Indicates a Command Error. This bit is set when a syntax error was detected in a remote command.

Bit0 – PWR: Indicates power is on.

The Standard Event Enable Register

The Standard Event Enable Register (ESE) is defined by the SCPI as a mask register for the ESR defined above. It is set and queried using the Common Command *ESE.

Bits in this register map to the bits of the ESR. The logical AND of the ESR and ESE registers sets the Standard Event register in the Status Byte (STB).

The Status Byte

The Status Byte (STB) is defined by the SCPI and is used to collect individual status bits from the ESE and the ISR as well as to identify that the instrument has a message for the host in it's output queue. It is queried using the Common Command *STB?. Bits are defined as follows:

STB

Bit7	Bit6	Bit5	Bit4	Bit3	Bit2	Bit1	Bit0
	RQS	SE	MAV	IE			

Where:

Bit6 – RQS: Request for Service.

Bit5 – SE: Standard Event. This bit is set as the logical 'AND' of the ESR and ESE registers.

Bit4 – MAV: Message Available

Bit3 – IE: Instrument Event. This bit is set as the logical 'AND' of the ISR and ISE registers.

The Status Byte Register

The Status Enable Register (SRE) is defined by the mask register for the STB. It is set and queried using the Common Commands *SRE.

Remote Command Tree

SYSTEM commands

```

SYSTem:ADRes <address>
SYSTem:AMBient?
SYSTem:BAUD {9600 | 19200 | 38400 | 57200}
SYSTem:BEEP <seconds>
SYSTem:DATE "mm/dd/yyyy"
SYSTem:DISCt {0.5 | 1 | 2 | 4 | 8 | 16 | 32 | 64}
SYSTem:DRES {FULL | 1 | 2 | 3}
SYSTem:FWREV?
SYSTem:HOME
SYSTem:HWRev?
SYSTem:RESeed
SYSTem:NAME "name"
SYSTem:NVSave
SYSTem:RESeed
SYSTem:TIME "hh:mm:ss"

```

Input Commands

```

INPut? {A | ... | H} or INPut {A | ... | H}:TEMPerature?
INPut {A | ... | H}:UNITs {K | C | F | S}
INPut {A | ... | H}:NAME "Instrument Name"
INPut {A | ... | H}:SENPr?
INPut {A | ... | H}:VBias {100MV | 10MV | 1.0MV}
INPut {A | ... | H}:BRANge {Auto | 1.0mA | 100uA | 10uA}
INPut {A | ... | H}::SENSorix <ix>
INPut {A | ... | H}:ALARm?
INPut {A | ... | H}:ALARm:HIGHest <setpt>
INPut {A | ... | H}:ALARm:LOWEst <setpt>
INPut {A | ... | H}:ALARm:HIENa { YES | NO }
INPut {A | ... | H}:ALARm:LOENa { YES | NO }
INPut {A | ... | H}:Clear
INPut {A | ... | H}:LTEna { YES | NO }
INPut {A | ... | H}:AUDio { YES | NO }
INPut {A | ... | H}:MINimum?
INPut {A | ... | H}:MAXimum?
INPut {A | ... | H}:VARiance?
INPut {A | ... | H}:SLOpe?
INPut {A | ... | H}:OFFSet?
INPut:STATs:TIME?
INPut:STATs:RESet
INPut {A | ... | H}:TCOFFset
INPut {A | ... | H}:TCGAin

```

Sensor Calibration Curve Commands

```

CALcur
SENSor <index>:NAME name string"
SENSor <index>:NENTry?
SENSor <index>:UNITs {VOLTS | OHMS | LOGOHM}
SENSor <index>:
  TYPE { DIODE | ACR | PTC100 | PTC1K |
  PTC10K | PTC10K | NTC10UA }
SENSor <index>:MULTiply <multiplier>

```

Data Logging Commands

DLOG:RUN {OFF | ON}
DLOG:TIME <Seconds>
DLOG:COUNT?
DLOG:READ?
DLOG:RESET
DLOG:CLEAR

Relay Commands

RELays? {0 | 1}
RELays {0 | 1} :SOURce {A | B | C | D}
RELays {0 | 1} :MODE {auto | control | on | off}
RELays {0 | 1} :HIGHest <setpt>
RELays {0 | 1} :LOWEST <setpt>
RELays {0 | 1} :DEADband <deadband>
RELays {0 | 1} :HIENa { YES | NO }
RELays {0 | 1} :LOENa { YES | NO }

Network Commands

NETWork:IPADdress
NETWork:MACaddress

Mail Commands

MAIL {A | ... | H} :ADDR "IPA"
MAIL {A | ... | H} :FROM "from e-mail address"
MAIL {A | ... | H} :DEST "to e-mail address"
MAIL {A | ... | H} :PORT <port number>
MAIL {A | ... | H} :STATE {ON | OFF}

IEEE Common Commands

*CLS
*ESE
*ESR
*OPC
*IDN?
*RST
*SRE
*STB

Remote Command Descriptions

IEEE Common Commands

*CLS

The *CLS common command clears the status data structures, including the device error queue and the MAV (Message Available) bit.

*ESE

The *ESE command sets the Standard Event Status Enable (ESE) Register bits. The ESE Register contains a bit mask for the bits to be enabled in the Standard Event Status (SEV) Register. A one in the ESE register will enable the corresponding bit in the SEV register. A zero will disable the bit.

The *ESE? Query returns the current contents of the ESE register.

*ESR

The *ESR query returns the contents of the Standard Event (SEV) status register.

*OPC

The *OPC command will cause the instrument to set the operation complete bit in the Standard Event (SEV) status register when all pending device operations have finished.

The *OPC Query places an ASCII '1' in the output queue when all pending device operations have completed.

*IDN?

The *IDN? Query will cause the instrument to identify itself. The Model 9308 will return the following string:

```
SI, Model 9308,<serial number>,<firmware revision>
```

Where: <serial number> is the unit's serial number and <firmware revision> is the revision level of the unit's firmware

*RST

Reset the instrument. This will cause a hardware reset in the Model 9308. The reset sequence will take about 15 seconds to complete. During that time, the instrument will not be accessible over any remote interface.

The *RST command sets the Model 9308 to its last power-up default setting.

*SRE

The *SRE command sets the Status Byte Enable (SRE) Register bits. The SRE Register contains a bit mask for the bits to be enabled in the Status Byte (STB) Register. A one in the SRE register will enable the corresponding bit in the STB register. A zero will disable the bit.

The *SRE? Query returns the current contents of the SRE register.

*STB?

The *STB query returns the contents of the Status Byte Register.

System Commands.

System commands are a group of commands associated with the overall status and configuration of the instrument rather than a specific internal subsystem.

SYSTEM:ADRS <address>

Selects the address that the IEEE-488.2 (GPIB) remote interface will use. The address is a numeric value between 1 and 31 with a factory default of 12. The addresses assigned to instruments must be unique on each GPIB bus structure. This command has no effect on other interfaces.

SYSTEM:AMBIent?

Queries the internal reference junction temperature. Value reported as a decimal number in units of Celsius.

SYSTEM:BAUD {9600 | 19200 | 38400 | 57200}

Sets or queries the RS 232 Baud rate.

SYSTEM:BEEP <seconds>

Asserts the audible alarm for a specified number of seconds. Command only, no query.

SYSTEM:DATE "mm/dd/yyyy"

Sets or queries the instrument's date. Date is in string format and is surrounded by double-quotes. Format is mm/dd/yyyy for month / day / year.

SYSTEM:DISTc {0.5 | 1 | 2 | 4 | 8 | 16 | 32 | 64}

Set or query the display filter time constant. The display filter is time-constant filter that is applied to all reported or displayed temperature data. Available time constants are 0.5, 1, 2, 4, 8, 16, 32 or 64 Seconds.

SYSTEM:DRES {FULL | 1 | 2 | 3}

Sets or queries the instrument's display resolution. Choices are:

- FULL: Display temperature with the maximum possible resolution.
- 1, 2 or 3: Display will display the specified number of digits to the right of the decimal point.

NOTE: This command only sets the number of digits displayed on the front panel display. It does NOT affect the internal accuracy of the instrument or the format of measurements reported on the remote interfaces.

The main use for this command is to eliminate the flicker in low order digits when the instrument is used in a noisy environment.

SYSTEM:FWREV?

Queries the instrument's firmware revision level.

SYSTEM:HOME

Causes the front panel display to go to the Operate Screen.

SYSTEM:HWRev?

Queries the instrument's hardware revision level.

SYSTEM:NAME "name"

The controller contains a unit name string that may be set or queried using this command. This can be used to assign a descriptive name to the instrument.

SYSTEM:NVSave

Save NV RAM to Flash. This saves the entire instrument configuration to flash memory so that it will be restored on the next power-up. Generally only used in environments where AC power is not toggled from the front panel. This includes remote and rack-mount applications.

SYSTem: RESeed

Re-seeds the input channel's averaging filter, allowing the reading to settle significantly faster. The display filter may have filter time-constants that are very long. The RESEED command inserts the current instantaneous temperature value into the filter history, thereby allowing it to settle rapidly.

Note: The RESEED command is useful in systems where a computer is waiting for a reading to settle. Issuing the RESEED command will reduce the required settling time of the reading.

SYSTem: TIME "hh:mm:ss"

Sets or queries the instrument's time. Time is in string format and is surrounded by double-quotes. Format is hh:mm:ss for hour:mm:ss. Twenty-four hour format is used.

Input Commands

The INPUT group of commands are associated with the configuration and status of the four input channels.

Parameter references to the input channels may be:

- Numeric ranging in value from zero to seven.
- Channel ID tags including CHA or CHB.
- Alphabetic including A or B.

INPut? {A | ... | H} or

INPut {A | ... | H}: TEMPerature?

The INPUT query reports the current temperature reading on any of the input channels. Temperature is filtered by the display time constant filter and reported in display units. Query only.

INPut {A | ... | H}: UNITs {K | C | F | S}

Sets or queries the display units of temperature used by the specified input channel. Units may be K for Kelvin, C for Celsius, F for Fahrenheit or S for primitive sensor units. In the case of sensor units, the instrument will determine if the actual units are Volts or Ohms based on the actual sensor type.

INPut {A | ... | H}: NAME Name String"

Sets or queries the name string for the selected input channel. The name string can be up to 15 ASCII characters. The string is used to name the input channel in order to clarify its use.

INPut {A | ... | H}: VBIs {100MV | 10MV}

Sets or queries the constant-voltage mode voltage used on the specified input channel. This value only applies to sensors that use constant-voltage excitation. They are indicated by a sensor type of ACR. If this query is used with a sensor type other than ACR, it will always return N/A for not applicable.

INPut {A | ... | H}: BRANge {Auto | 1.0mA | 100uA | 10uA}

Sets or queries the resistance bridge excitation range. This is a range-hold function. Normally, this is set to auto so that the instrument will autorange excitation. For special applications, the resistance bridge may be set to a specific excitation range.

INPut {A | ... | H}: SENPr?

The INPUT:SENPR query reports the reading on a selected input channel. For diode sensors, the reading is in Volts while resistor sensors are reported in Ohms. The reading is not filtered by the display time-constant filter. However, the synchronous input filter has been applied. Query only.

INPut {A | ... | H}: SENSor <ix>

Sets or queries the sensor index number. <ix>, is taken from Appendix A.

INPut {A | ... | H}:ALARm?

Queries the alarm status of the specified input channel. Status is a two character string where:

- indicates that no alarms are asserted
- SF indicates a Sensor Fault condition.
- HI indicates a high temperature alarm
- LO indicates a low temperature alarm.

There is a 0.25K hysteresis in the assertion of a high or low temperature alarm condition.

The user selectable display time constant filter is applied to input channel temperature data before alarm conditions are tested.

INPut {A | ... | H}:ALARm:HIGHest <setpt>

Sets or queries the temperature setting of the high temperature alarm for the specified input channel. When this temperature is exceeded, an enabled high temperature alarm condition will be asserted.

Temperature is assumed to be in the display units of the selected input channel. There is a 0.25K hysteresis in the assertion of a high or low temperature alarm condition.

<setpt> is the alarm setpoint temperature.

INPut {A | ... | H}:ALARm:LOWEst <setpt>

Sets or queries the temperature setting of the low temperature alarm for the specified input channel. When the input channel temperature is below this, an enabled low temperature alarm condition will be asserted.

Temperature is assumed to be in the display units of the selected input channel. There is a 0.25K hysteresis in the assertion of a high or low temperature alarm condition.

<setpt> is the alarm setpoint temperature.

INPut {A | ... | H}:ALARm:HIENa {YES | NO}

Sets or queries the high temperature alarm enable for the specified input channel. An alarm must be enabled before it can be asserted.

INPut {A | ... | H}:ALARm:LOENa {YES | NO }

Sets or queries the low temperature alarm enable for the specified input channel. An alarm must be enabled before it can be asserted.

INPut {A | ... | H}:ALARm:CLEAr

Clears any latched alarm on the selected input channel.

INPut {A | ... | H}:ALARm:AUDio {YES | NO }

Sets or queries the audio alarm enable. When enabled, an audio alarm will sound whenever an alarm condition is asserted.

INPut {A | ... | H}:MINimum?

Queries the minimum temperature that has occurred on an input channel since the STATS:RESET command was issued.

INPut {A | ... | H}:MAXimum?

Queries the maximum temperature that has occurred on an input channel since the STATS:RESET command was issued.

INPut {A | ... | H}:VARiance?

Queries the temperature variance that has occurred on an input channel since the STATS:RESET command was issued. Variance is calculated as the Standard Deviation squared.

INPut {A | ... | H}:SLOpe?

Queries the input channel statistics. SLOPE is the slope of the best fit straight line passing through all temperature samples that have been collected since the STATS:RESET command was issued. SLOPE is in units of the input channel display per Minute.

INPut {A | ... | H}:OFFSet?

Queries the input channel statistics. OFFSET is the offset of the best fit straight line passing through all temperature samples that have been collected since the STATs:RESEt command was issued. OFFSET is in units of the input channel display.

INPut {A | ... | H}:STATs:TIME?

Queries the time duration over which input channel statistics have been accumulated. Time is reset by issuing the STAT:RESEt command. Query only.

INPut {A | ... | H}:STATs:RESEt

Resets the accumulation of input channel statistical data. Command only affects the selected input channel.

INPut {A | ... | H}:TCOFFset <offset>

Sets or queries the offset value for thermocouple inputs. <offset> is the decimal value of offset and is in units of Kelvin. Refer to the section on [Using Thermocouple Sensors](#) for more information.

INPut {A | ... | H}:TCGAin <gain>

Sets or queries the gain value for thermocouple inputs. <gain> is the decimal value of the gain applied to thermocouple readings and is in units of volts per volts. Refer to the section on [Using Thermocouple Sensors](#) for more information.

Relay Commands

The relay subsystem includes the two auxiliary relays in the Model 9308. Using the RELAYS commands, these relays are independently configured to assert or clear based on the status of any of the four sensor input channels.

Relay outputs are dry-contact and are available on the rear panel of the instrument.

The user selectable display time constant filter is applied to input channel temperature data before relay conditions are tested. The user selectable relay deadband is also applied.

RELays? {0 | 1}

Relay Status Query. The two auxiliary relays available in the Model 9308 are addressed as 0 and 1. The RELAYS command can be used to query the status of each relay where:

--	Relay is in Auto mode and is clear.
Hi	Relay is asserted by a high temperature condition.
Lo	Relay is asserted by a low temperature condition.
ON	Relay is in manual mode and is asserted.
OFF	Relay is in manual mode and is clear.

RELays {0 | 1}:SOURCE {A | ... | H}

Relay Input Source. Sets or queries the source input channel for a specified relay.

RELays {0 | 1}:HIGHest <setpt>

Relay High setpoint. Sets or queries the temperature setting of the high temperature setpoint for the specified relay. Parameter <setpt> is floating-point numeric and is in units of the controlling input channel.

RELays {0 | 1}:MODE {AUTO | ON | OFF}

Set or query the relay mode. Modes are:

Auto	Relay is controlled by enabled high and low setpoints.
ON	Relay is in manual mode and is asserted.
OFF	Relay is in manual mode and is clear.
Control	Relay is asserted whenever the controller is in Control mode.

RELays {0 | 1}:LOWest <setpt>

Relay Low setpoint. Sets or queries the temperature setting of the low temperature setpoint for a specified relay. Parameter <setpt> is floating-point numeric and is in units of the controlling input channel.

RELAys {0 | 1} : HIENa {YES | NO }

Relay High Enable. Sets or queries the high temperature enable for the specified relay.

RELAys {0 | 1} : LOENa {YES | NO }

Relay Low Enable. Sets or queries the low temperature enable for the specified relay.

RELAys {0 | 1} : DEAdband <dead-band>

Sets or queries the dead-band parameter. This controls the amount of hysteresis that is applied before a relay is asserted or cleared. Parameter <dead-band> is floating-point numeric and is in units of the controlling input channel.

Sensor Calibration Curve Commands

The CALCUR commands are used to transfer sensor calibration curves between the instrument and the host controller.

Curves are referenced by an index number. In the Model 9308, there are eight user curves numbered 1 through 8.

The CALCUR data block consists of many lines of ASCII text. The format is the same as the file format for user calibration curves, which is detailed in the section [User Calibration Curve File Format](#).

CALCUR <index>

Sets or queries sensor calibration curve data.

Uses a fragmented message protocol to send many lines of ASCII text to the instrument.

Note: It is much easier to use the Utility Software to send and receive sensor calibration curves.

Sensor commands

Sensor commands are used to set and query information about the sensors installed in the controller. Both factory and user installed sensors can be queried, but only user sensors may be edited.

ⓘ **NOTE:** Factory installed sensors are indexed from 0 to 61. User installed sensors have index values from 61 to 68 corresponding to user curves 1 through 8. For additional information, refer to [Appendix A](#).

SENSorix <index>:name "Name String"

Sets and queries the name string of the user-installed sensor at index <index>. The name string can be up to 15 ASCII characters.

SENSorix <index>:NENTry?

Queries the number of entries in the user-installed sensor at index <index>. Response is a decimal integer ranging from zero to 200.

SENSorix <index>:UNITs {VOLT| LOGOHM | OHMS}

Sets or queries the units of a user installed calibration curve at <index>. For information on the curve units, refer to the [User Calibration Curve File Format](#) section.

SENSorix <index>:

TYPE {DIODE | ACR | PTC100 | PTC100 | PTC100 | NTC10UA}

Sets or queries the type of sensor at <index>. For more information on sensor types, please refer to the [Input Configurations](#) section. Index is 0 through 7.

SENSorix <index>:MULTiplier <multiplier>

Sets or queries the multiplier field of a user installed calibration curve at <index>. For information on the multiplier, refer to the [User Calibration Curve File Format](#) section.

Network Commands

The following commands are used to configure the Model 9308's Ethernet interface.

NETWork: IPADdress "IPA"

Sets or queries the instrument's IP address. The address is expressed as an ASCII string, so the input parameter must be enclosed in quotes. For example, the default IP address parameter is "192.168.1.4".

NETWork: MACADdress?

Queries the instrument's MAC address. The address is returned as an ASCII string. MAC addresses range from 00:50:C2:6F:40:00 to 00:50:C2:6F:4f:ff. They cannot be changed by the user.

Mail Commands

The Model 9308 can send e-mail over the Ethernet port when an alarm condition is asserted on an enabled input channel. The following remote commands are used to configure e-mail. However, it is much easier to configure e-mail using the instrument's embedded web server.

MAIL {A | ... | H}:ADDR "IPA"

Set or query the e-mail server IP address. Parameter format is an ASCII string and must be enclosed in quotation marks. For example: "192.168.0.1".

MAIL {A | ... | H}:FROM "from e-mail address"

Set or query the 'from' e-mail address. Parameter is an ASCII String. For example: "model9308@mynetwork.com".

MAIL {A | ... | H}:DEST "to e-mail address"

Set or query the 'to' e-mail address. Parameter is an ASCII String. For example: "model9308@mynetwork.com".

MAIL {A | ... | H}:PORT <port number>

Set or query the e-mail port. Parameter is integer and default is 25.

MAIL {A | ... | H}:STATE {ON | OFF}

Set or query the input channel e-mail send enables. If a channel is enabled, e-mail will be sent when an alarm condition is asserted on the selected input channel.

Data Logging Commands

DLOG: STATE {ON|OFF}

Turns the data logging function ON or OFF. Equivalent to Start / STOP.

DLOG: INTERVAL <Seconds>

Sets the data logging time interval in seconds.

DLOG: COUNT?

Queries the number of entries in the log buffer.

DLOG?

DLOG: READ?

Reads the entire contents of the log buffer. Each record is sent on a single line. Format is:

<#>, MM/DD/YYYY, HR,MN,SC, ChA, CHB, ChC,ChD

where:

<#> is the record number.

MM/DD/YYYY is the date in Month, Day, Year format.

HR,MN,SC is the time in Hour, Minute, Second format.

Lines end with a <CR><LF> sequence. End of transmission is indicated by a line that only contains a semi-colon.

DLOG: RESET

Sets the logging record number to zero.

DLOG: CLEAR

Clears the data logging buffer.

Code snippet in C++

The following code opens an instrument at address 192.168.1.4 on the Local Area Network. It is written in Microsoft Visual C++ and uses the eZNET LAN library provided on the utility CD.

```
// ----- Example Ethernet LAN program using C++ -----
// TCPIP declarations
#include "TCPIPdrv.h"

TCPIPdrv LAN; //Define global LAN object
char IPA[ ] = "192.168.1.4"; //Instrument's IP address on the LAN
char tempstr[257]; //temporary character string

//Open the instrument.
If(!LAN.open(IPA)){
    //can't connect...
    LAN.close();
    throw ("Can't talk to instrument");
};
//read the IDN string
LAN.IO("*IDN?",tempstr,256);
printf("IDN is %s\n",tempstr); //Print IDN

//read the MAC address
LAN.IO("net:mac?",tempstr,256);
printf("MAC is: %s\n",tempstr);

//Start temperature control
LAN.IO("control");

//Stop temperature control
LAN.IO("stop");

//Read channel B input
LAN.IO("input? B",tempstr,256);
printf("Channel B temperature is: %s\n",tempstr);

//send compound command to input channel A and wait for it to finish.
LAN.IO("INPUT A:UNIT S;ISENIX 33;:*OPC?",tempstr,256);

//close the instrument
LAN.close();
```

EU Declaration of Conformity **According to ISO/IEC Guide 22 and EN 45014**

Product Category: Process Control Equipment
Product Type: Temperature Measuring System
Model Numbers: Model 9308, Model 9304 and Model 9302
Manufacturer's Name: Scientific Instruments, Inc.
Manufacturer's Address:
4400 W Tiffany Dr
West Palm Beach, FL 33407
Tel: (561) 881- 8500, Fax: 561.881.8556

The before mentioned products comply with the following EU directives:

89/336/EEC, "Council Directive of 3 May 1989 on the approximation of the laws of the Member States relating to electromagnetic compatibility"

73/23/EEC, "Council Directive of 19 February 1973 on the harmonization of the laws of Member States relating to electrical equipment designed for use within certain voltage limits".

The compliance of the above mentioned product with the Directives and with the following essential requirements is hereby confirmed:

<u>Emissions</u>	<u>Immunity</u>	<u>Safety</u>
EN 55011,1998	EN 50082-1, 1997	EN 61010, 1994 A2: May 96

The technical files and other documentation are on file with at the above address or at a subcontracted testing facility.

As the distributor and exporter we declare under our sole responsibility that the above mentioned products comply with the above named directives.



Leigh Ann Hoey
President, Scientific Instruments, Inc.
October 31, 2012

Appendix A: Installed Sensor Curves

Factory Installed Curves

The following is a list of factory-installed sensors and the corresponding sensor index (ISENIX).

Sensor IX	Name	Description
0	None	No Sensor. Used to turn the selected input channel off.
1	SI430 Diode	Scientific Instruments Inc. SI430/440 series Silicon diode. Range: 1.4 to 500K. 10 μ A constant current excitation.
2	LS DT-670	Lakeshore DT-670 series Silicon diode, Curve 11. Range: 1.4 to 500K. 10 μ A constant current excitation.
3	LS DT-470	Lakeshore DT-470 series Silicon diode, Curve 10. Range: 1.4 to 500K. 10 μ A constant current excitation.
4	CD-12A	Cryo Industries CD-12A Silicon diode. Range: 1.4 to 500K. 10 μ A constant current excitation.
5	SI 410 Diode	Scientific Instruments, Inc. 410 diode Curve. Range: 1.5 to 450K. 10 μ A excitation.
20	Pt100 385	DIN43760 standard 100 Ω Platinum RTD. Range: 23 to 873K, 1mA excitation.
21	Pt1K 385	1000 Ω at 0 $^{\circ}$ C Platinum RTD using DIN43760 standard calibration curve. Range: 23 to 1023K, 100 μ A excitation.
22	Pt10K 385	10K Ω at 0 $^{\circ}$ C Platinum RTD. Temperature coefficient 0.00385, Range: 23 to 873K, 10 μ A excitation.
23	RhFe 27, 1mA	Rhodium-Iron. 27 Ω at 0 $^{\circ}$ C. 1mA DC excitation. 1.5 to 873K
31	SI RO-105	Scientific Instruments Inc. RO-105 Ruthenium Oxide sensor. Temperature range is: 2 to 273K. Use with the NTC10uA input configuration only.
32	SI RO-600	Scientific Instruments Inc. RO-600 Ruthenium-Oxide sensor with constant-voltage AC excitation. Temperature range is: <50mK to 40K. Use 10mV bias.
33	Cryo-con R500	Cryocon R500 Ruthenium-Oxide sensor with constant-voltage AC excitation. Temperature range is: <50mK to 40K. Use 10mV bias.
34	Cryo-con R400	Cryocon R400 Ruthenium-Oxide sensor. Temperature range is: 2 to 273K. Use with the NTC10uA input configuration only.
45	TC Type K	Thermocouple, Type K. Range: 3.2 to 1643K
46	TC Type E	Thermocouple, Type E. Range: 3.2 to 1273K
47	TC Type T	Thermocouple, Type T. Range: 3.2 to 673K
48	TC AuFe .07%	Chromel-AuFe 7% thermocouple. Range: 3 to 610K
0	None	No Sensor. Used to turn the selected input channel off.

The SENSORIX remote commands are used to query and edit sensors installed in the controller. For example, the command:

INPUT B SENSORIX 34 would set input B to use the R400 sensor.
 INPUT A: SENSORIX 1 would set input A to use the Si430 diode.
 INPUT A: SENSORIX 0 would turn input A off by setting the sensor to 'none'.
 SENSORIX 1:NAME? Returns the name string at index 1.

Factory installed sensors may not be edited by using these commands.

User Installed Sensor Curves

The user may install up to eight custom sensors. This table shows the sensor index and default name of the user curves:

User Curve	Sensor IX	Default Name
0	61	User Sensor 1
1	62	User Sensor 2
2	63	User Sensor 3
3	64	User Sensor 4
4	65	User Sensor 5
5	66	User Sensor 6
6	67	User Sensor 7
7	68	User Sensor 8

Using the above table, the SENSORIX commands can be used to address the user curves. For example:

INPUT B SENSORIX 62 assigns input B to user sensor #2.
SENSORIX 64:NAME? Returns the name string of user sensor 4
SENSORIX 63:TYPE ACR sets the type of user sensor #3 to ACR.

<p>ⓘ NOTE: Factory installed sensors are indexed from 0 to 61. User installed sensors have index values from 61 to 68 corresponding to user curves 1 through 8.</p>
--

Sensor Curves on CD

The following sensors are available on the CD supplied:

File	Description
Cryocon S700	Cryo-con S700 series Silicon diode. Range: 1.4 to 500K. 10 μ A constant current excitation.
CryocalD3.crv	Cryocal D3 Silicon diode. Range: 1.5 to 300K
SI410.crv	Scientific Instruments, Inc. SI-410 Silicon diode. Range: 1.5 to 450K
Curve10.crv	Lakeshore Curve 10 Silicon diode curve for DT-470 series diodes. Range: 1.4 to 495K.
Curve11.crv	Lakeshore Curve 10 Silicon diode curve for DT-670 series diodes. Range: 1.4 to 500K.
PT100385.crv	Cryocon CP-100, DIN43760 or IEC751 standard Platinum RTD, 100 Ω at 0 $^{\circ}$ C. Range: 23 to 1020K
PT1K385.crv	DIN43760 or IEC751 standard Platinum RTD, 1000 Ω at 0 $^{\circ}$ C. Range: 23 to 1020K
PT1003902.crv	Platinum RTD, 100 Ω at 0 $^{\circ}$ C Temperature coefficient 0.003902 Ω /C. Range: 73K to 833K.
PT1K375.crv	Platinum RTD, 1000 Ω at 0 $^{\circ}$ C Temperature coefficient 0.00375 Ω /C. Range: 73K to 833K.
aufe07cr.crv	Chromel-AuFe 7% thermocouple. Range: 3 to 610K
TCTypeE.crv	Thermocouple, Type E. Range: 3.2 to 1273K
TCTypeK.crv	Thermocouple, Type K. Range: 3.2 to 1643K
TCTypeT.crv	Thermocouple, Type T. Range: 3.2 to 673K
CX1030E1.crv	Cernox TM CX1030 example curve. Range: 4 to 325K

User Calibration Curve File Format

Sensor calibration curves may be sent to an instrument using a properly formatted text file. This file has the extension .crv. It consists of a header block, lines of curve data and is terminated by a single semicolon (;) character.

The header consists of four lines as follows:

```
Sensor Name:  Sensor name string
Sensor Type:  Enumeration
Multiplier:   Signed numeric
Units:        Units of calibration curve: {OHMS | VOLTS | LOGOHM}
```

The Sensor Name string can be up to 15 characters and is used to identify the individual sensor curve. When downloaded to an instrument, this name appears in the sensor selection menu of the embedded web server and will appear on all sensor selection fields on the front panel.

The Sensor Type Enumeration identifies the required input configuration of the input channel. For the Model 9308, selections are: DIODE, PTC100, PTC1K, PTC10K, NTC10uA and ACR. These configurations are described in the section titled [Supported Sensor Configurations](#).

The Multiplier field is a signed, decimal number that identifies the sensor's temperature coefficient and curve multiplier. Generally, for Negative-Temperature-Coefficient (NTC) sensors, the value of the multiplier is -1.0 and for a Positive-Temperature-Coefficient (PTC) sensor, the value is 1.0.

As an advanced function, the multiplier field can be used as a multiplier for the entire calibration curve. For example, a 10K Ω Platinum RTD can use a calibration curve for a 100 Ω Platinum RTD by using a multiplier of 100.0.

The fourth line of the header is the sensor units field. This may be Volts, Ohms or Logohm. Generally, diode type sensor curves will be in units of Volts and most resistance sensors will be in units of Ohms. However, many resistance sensors used at low temperature have highly nonlinear curves. In this case, the use of Logohm units give a more linear curve and provide better interpolation accuracy. Logohm is the base-10 logarithm of Ohms.

Examples of sensor calibration curves that are in units of Ohms include Platinum RTDs and Rhodium-Iron RTDs. Examples of sensors that best use Logohm include Cernox™, Ruthenium-Oxide and Carbon-Ceramic.

After the header block, there are two to 200 lines of sensor calibration data points. Each point of a curve contains a sensor reading and the corresponding temperature. Sensor readings are in units specified by the units line in the curve header. Temperature is always in Kelvin.

The format of an entry is:

```
<sensor reading> <Temperature>
```

Where <sensor reading> is a floating-point sensor reading and <Temperature> is a floating-point temperature in Kelvin. Numbers are separated by one or more white spaces.

Floating point numbers may be entered with many significant digits. They will be converted to 32 bit floating point which supports about six significant digits.

The last entry of a table is indicated by a semicolon (;) character with no characters on the line.

NOTE: All curves must have a minimum of two entries and a maximum of 200 entries.
--

Entries may be sent to the instrument in any order. The instrument will sort the curve in ascending order of sensor reading before it is copied to Flash RAM. Entries containing invalid numeric fields are deleted before the curve is stored.

The following is an example of a calibration curve transmitted to the instrument via the LAN interface:

```
Good Diode
Diode
-1.0
volts
0.34295 300.1205
0.32042 273.1512
0.35832 315.0000
1.20000 3.150231
1.05150 8.162345
0.53234 460.1436
;
```

In summary,

1. The first line is a name string that can be up to 15 characters. Longer strings are truncated by the instrument.
The second line identifies the instrument's input configuration and must be one of the allowed selections described in the [Supported Sensor Configurations](#) section.
2. The third line is the multiplier field and is 1.0 for PTC sensors and -1.0 for NTC sensors or diodes.
3. The fourth line of the header is the sensor units and must be Volts, Ohms or Logohm.
4. Curve entries must be the sensor reading followed by the temperature in units of Kelvin. Values are separated by one or more white space or tab characters.
5. The last line in the file has a single semicolon (;) character. All lines after this are rejected.
6. It is recommended that the curve back is read after downloading to ensure that the instrument parsed the file correctly. This is easily done by using the utility software's curve upload function under Operations>Sensor Curve>upload.

Appendix B: Updating Instrument Firmware

Updates require the use of the Firmware Update Utility software and a hex file containing the updated firmware.

ⓘ Note: Updating firmware in any instrument is not entirely without risk. Please only perform the procedure when some down time is available. The update will abort on the detection of a hardware malfunction. Also, the update may change instrument features that you are currently using in a different way. Factory defaults settings are restored that will erase any existing user calibration curves or PID tables.

Discussion

Monitor instruments have two blocks of flash type program memory. In the standard configuration, the Internal block contains a boot-loader program and the External block contains the actual instrument firmware.

During the normal power-up sequence, the boot-loader tests the external flash memory and then transfer execution to it in order to run the instrument's firmware. From there, the firmware update utility can be used to update instrument's firmware.

The firmware update sequence is as follows:

1. Connect the LAN port of the instrument to your PC, turn the instrument ON and then run the FWutility.exe.
2. Click the Connect button to connect the PC to the instrument using TCP/IP. If there is an error, a dialog box will appear. Correct the problem and re-try.
3. While connected, the instrument still functions normally. Click on the Set Flash Mode button to place the instrument in the firmware update mode. In this mode, the instrument executes the boot-loader from the Internal flash memory and is waiting to program the External memory with the new firmware.
4. Click Connect again and then click the Program / Verify button to start the update process.
5. When the update process is complete, the instrument will automatically reset itself and start running the updated firmware.

Updating unit firmware

Before starting, be sure to have the **FWutility.exe** file and a hex file that contains the desired firmware update.

On the instrument, check the current hardware and firmware revision by pressing the System key and scrolling down to the revision field. A typical display is:

FW Ver: 3.00D

meaning that the instrument has firmware revision 3.00 and hardware revision D.

The name of the hex file is used to identify the firmware update update. For example:

M9308C_301.hex

specifies that this is revision 3.01 for a Model 9308 with hardware revision C.

ⓘ Note: The flash loader software does NOT check the hex file for compatibility with the target instrument. Please be sure that you are using the correct file.

Connecting a PC to the instrument

It is recommended that the instrument is connected directly to a PC using a LAN Crossover cable. The standard LAN patch cable is designed to connect a PC to a hub and will not work when used to connect to an instrument. The Crossover cable has the transmit and receive lines reversed, which allows direct

connection to an instrument. These cables should be clearly marked with the word 'Crossover'.

From the PC, open the network connections dialog, select the network adapter that you are using with the instrument and select "Internet Protocol (TCP/IP). In the TCP/IP dialog box, select 'Use the following IP' addresses and enter following:

IP address: 192.168.1.10
Subnet mask: 255.255.255.0

Other fields are not used. Click OK. This should allow you to communicate with the instrument.

ⓘ The advanced user can configure the Ethernet connection in any convenient way. The above procedure is given because it is known to work. The instrument will keep the assigned IP through the entire update process. However, when the update is complete, factory defaults are restored and the IP will be set to 192.168.1.5.

Loading Firmware

Start the firmware update by running the Firmware Utility. This launches a dialog box as shown here.

The instrument's default IP will appear in the dialog box. This can be changed if necessary.

Click the **Connect** button. The status box should update to indicate a connection, but the instrument display will not change.

Next, the firmware update file needs to be selected. Click on the browse button (. . .) to launch a file selection dialog.

Select the firmware hex file and click **Open**. The Firmware HEX file field will be updated with the file name. Also, the **Set Flash Mode** button will become active.



Caution: Once you click the **Set Flash Mode** button, the instrument will enter the firmware update mode and will not function normally again until the entire firmware update process is complete without error. Be sure you have the correct hex file before proceeding.

Click the **Set Flash Mode** button to set the instrument into the flash programming mode. The instrument will reset and start in the flash load mode. This is indicated by the display shown.

Since the instrument was reset, click **Connect** again to re-establish contact. This activates the **Program/Verify** button. The instrument will now display "Connected..."

```
Scientific Instruments, Inc.  
Boot Loader Waiting for connect.  
IP:192.168.1.5      Port:5000 Rev:1.07A
```

Click the **Program/Verify** button to start the firmware download.

The last few lines of the instrument's display will indicate the status. First, the flash memories are erased and then individual records are programmed and verified.

There are about 6800 records in a typical file and the programming process takes about ten minutes.

When programming is complete, the unit will automatically reset and begin running the updated firmware. Factory defaults are also restored.

It is possible to power the instrument OFF during the programming process. This will require a re-start of the entire process after powering ON again. Once the download progress starts, the instrument powers-up in the boot loader mode and will not run the normal instrument firmware until the entire download process is completed without error.



If an error occurs, an error message will display on the instrument's front panel for 20 seconds and then an alert box will show on the PC.

Types of errors are: 1) Failure to erase flash memory. 2) Write error and 3) Verify error.

If the error persists after several programming attempts, there is a hardware problem and you will need to contact Scientific Instruments.

Appendix C: Troubleshooting Guide

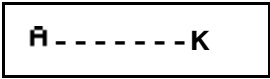
Error Displays

Display	Condition
 Or an erratic display of temperature.	Input channel voltage measurement is out of range. Ensure that the sensor is connected and properly wired. Ensure that the polarity of the sensor connections is correct. Refer to the Sensor Connections section. Many sensors can be checked with a standard Ohmmeter. For resistor sensors, ensure that the resistance is correct by measuring across both the Sense and Excitation contacts. For a diode sensor, measure the forward and reverse resistance to ensure a diode-type function.
	Input channel is within range, but measurement is outside the limits of the selected sensor's calibration curve. Check sensor connections as described above. Ensure that the proper sensor has been selected. Refer to the Input Channel Setup Menus section. Change the sensor units to Volts or Ohms and ensure that the resulting measurement is within the selected calibration curve.

Temperature Measurement Errors

Symptom	Condition
Noise on temperature measurements.	Possible causes: <ol style="list-style-type: none"> Excessive noise pickup, especially AC power line noise. Check your wiring and shielding. Sensors must be floating, so check that there is no continuity between the sensor connection and ground. Review the System Shielding and Grounding Issues section. Check for shielding problems by temporarily removing the input connector's backshell. If the noise changes significantly, current is being carried by the shields and is being coupled into the instrument. Use a longer display filter time constant to reduce displayed noise.

Symptom	Condition
DC offset in temperature measurements.	Possible causes: <ol style="list-style-type: none"> The wrong sensor type or sensor calibration curve is being used. Refer to the Input Channel Configuration Menu section. DC offset in cryostat wiring. Review the Thermal EMF and AC Bias Issues section. Use AC bias, if necessary, to cancel the offset error. A four-wire measurement is not being used. Some cryostats use a to a two-wire measurement internally. This can cause offset errors due to lead resistance. Thermocouples: These sensors will often have DC offset errors. Use the CalGen feature to generate a new sensor calibration curve that corrects for these errors.
No temperature reading.	Review the Error Displays section above.

Remote I/O problems

Symptom	Condition
<p>Can't talk to RS-232 interface.</p>	<p>Possible causes:</p> <ol style="list-style-type: none"> 1. Ensure that the RS-232 port is selected. Press the System key and scroll down to the RIO-Port: field. 2. Ensure that the baud rate of the controller matches that of the host computer. To check the controller's baud rate, press the System key and scroll down to the RIO-RS232 field. 3. Ensure that the host computer settings are 8-bits, No parity, one stop bit. 4. The RS-232 port does not have an effective hardware handshake method. Therefore, terminator characters must be used on all strings sent to the controller. Review the RS-232 Configuration section. 5. Ensure that you are using a Null-Modem type cable. There are many variations of RS-232 cables and only the Null-Modem cable will work with the monitors. This cable is detailed in the RS-232 Connections section. <p>Debugging tip: Utility software can be used to talk to the controller over the RS-232 port using the terminal mode. All command and response strings are displayed. This is a good way to establish a connection.</p>
<p>Intermittent lockup on RS-232 interface.</p>	<p>Possible causes:</p> <ol style="list-style-type: none"> 1. Long cables. Try using a lower baud rate. In some cases, inserting a 50mS delay between commands will help. 2. Noise pickup. Try using shielded cables with the shield connected to a metal backshell at both ends. 3. Don't send reset (RST) commands to the controller before reading.
<p>Can't talk to the LAN interface.</p>	<p>Possible causes:</p> <ol style="list-style-type: none"> 1. A Category 5 crossover patch cable is being used where a Category 5 patch cable should be used, or visa-versa. 2. The TCP settings between the monitor and the PC are incompatible. Review the network configuration section. 3. PC Client software not configured to use TCP Data Socket 5000. <p>Debugging tip: Utility software can be used to talk to the monitor over the LAN Data Socket port using the terminal mode. All command and response strings are displayed. Since the software provides the proper interface setup, it is a good way to establish initial connection.</p>

Appendix D: Enclosure Options

Panel Mounting

Panel Cutout

Shown here is a cut-out drawing for panel mounting of the Model 9308.

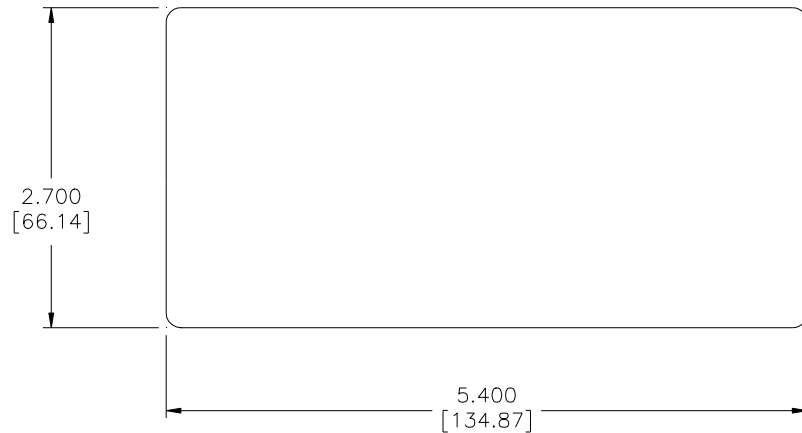

Panel Mount Kit

The Model 9308 mounts to panel by sliding the enclosure through a panel cut-out hole and then installing the panel mount kit, part number 305-240. Drawings and assembly of the panel mount kit are shown here.

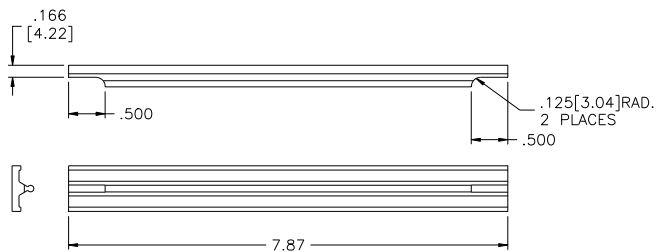
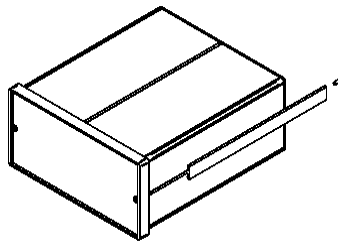

Instrument Stand

The Instrument Stand accessory, part number 300-011, is used to mount the Model 9308 on a bench top. It tilts the instrument up by 15° for an improved viewing angle.



Appendix E: Sensor Data

Cryo-con S700 Silicon Diode

The Cryo-con S700 Silicon diode sensor with a 10 μ A excitation current.

	Volts	Temp (K)		Volts	Temp (K)		Volts	Temp (K)
1	0.1633	475.0000	41	0.6393	260.0000	81	1.2510	18.0000
2	0.1733	470.0000	42	0.6586	250.0000	82	1.2720	17.0000
3	0.1834	465.0000	43	0.6807	240.0000	83	1.2950	16.0000
4	0.1935	460.0000	44	0.7040	230.0000	84	1.3280	15.0000
5	0.2038	455.0000	45	0.7238	220.0000	85	1.3650	14.0000
6	0.2141	450.0000	46	0.7461	210.0000	86	1.4150	13.0000
7	0.2246	445.0000	47	0.7682	200.0000	87	1.4700	12.0000
8	0.2351	440.0000	48	0.7916	190.0000	88	1.5270	11.0000
9	0.2458	435.0000	49	0.8133	180.0000	89	1.5750	10.0000
10	0.2565	430.0000	50	0.8338	170.0000	90	1.5990	9.5000
11	0.2673	425.0000	51	0.8547	160.0000	91	1.6230	9.0000
12	0.2781	420.0000	52	0.8753	150.0000	92	1.6540	8.5000
13	0.2891	415.0000	53	0.8977	140.0000	93	1.6670	8.0000
14	0.3001	410.0000	54	0.9198	130.0000	94	1.6840	7.5000
15	0.3111	405.0000	55	0.9373	120.0000	95	1.7080	7.0000
16	0.3222	400.0000	56	0.9542	110.0000	96	1.7310	6.5000
17	0.3334	395.0000	57	0.9768	100.0000	97	1.7500	6.0000
18	0.3446	390.0000	58	0.9865	95.0000	98	1.7690	5.5000
19	0.3558	385.0000	59	0.9950	90.0000	99	1.7850	5.0000
20	0.3671	380.0000	60	1.0050	85.0000	100	1.7970	4.7500
21	0.3784	375.0000	61	1.0144	80.0000	101	1.8000	4.5000
22	0.3897	370.0000	62	1.0241	75.0000	102	1.8090	4.2500
23	0.4011	365.0000	63	1.0325	70.0000	103	1.8160	4.0000
24	0.4125	360.0000	64	1.0420	65.0000	104	1.8210	3.7500
25	0.4239	355.0000	65	1.0506	60.0000	105	1.8270	3.5000
26	0.4353	350.0000	66	1.0587	55.0000	106	1.8340	3.2500
27	0.4467	345.0000	67	1.0673	50.0000	107	1.8390	3.0000
28	0.4581	340.0000	68	1.0753	45.0000	108	1.8460	2.7500
29	0.4695	335.0000	69	1.0842	40.0000	109	1.8520	2.5000
30	0.4808	330.0000	70	1.0870	38.0000	110	1.8560	2.2500
31	0.4922	325.0000	71	1.0904	36.0000	111	1.8590	2.0000
32	0.5035	320.0000	72	1.0941	34.0000	112	1.8630	1.7500
33	0.5148	315.0000	73	1.0974	32.0000	113	1.8660	1.5000
34	0.5261	310.0000	74	1.1011	30.0000			
35	0.5373	305.0000	75	1.1054	28.0000			
36	0.5485	300.0000	76	1.1108	26.0000			
36	0.5596	295.0000	77	1.1238	24.0000			
38	0.5707	290.0000	78	1.1650	22.0000			
39	0.5900	280.0000	79	1.2070	20.0000			
40	0.6131	270.0000	80	1.2290	19.0000			

Scientific Instruments Si430 Silicon Diode

The Scientific Instruments Si430 Silicon diode sensor with a 10 μ A excitation current.

Volts	Temp(K)	Volts	Temp(K)	Volts	Temp(K)
0.09077	500.00	0.86921	160.00	1.06858	52.00
0.09281	499.00	0.87959	155.00	1.07023	51.00
0.11153	490.00	0.88988	150.00	1.07188	50.00
0.13320	480.00	0.90008	145.00	1.07353	49.00
0.15565	470.00	0.91021	140.00	1.07517	48.00
0.17873	460.00	0.92022	135.00	1.07681	47.00
0.20231	450.00	0.93008	130.00	1.07844	46.00
0.22623	440.00	0.93976	125.00	1.08008	45.00
0.25016	430.00	0.94927	120.00	1.08171	44.00
0.27403	420.00	0.95867	115.00	1.08334	43.00
0.29785	410.00	0.96794	110.00	1.08497	42.00
0.32161	400.00	0.97710	105.00	1.08659	41.00
0.34532	390.00	0.98615	100.00	1.08821	40.00
0.34768	389.00	0.99510	95.00	1.08983	39.00
0.36898	380.00	1.00393	90.00	1.09145	38.00
0.39261	370.00	1.00569	89.00	1.09306	37.00
0.41620	360.00	1.00744	88.00	1.09468	36.00
0.43976	350.00	1.00918	87.00	1.09629	35.00
0.46330	340.00	1.01093	86.00	1.09791	34.00
0.48681	330.00	1.01267	85.00	1.09952	33.00
0.51024	320.00	1.01439	84.00	1.10124	32.00
0.52192	315.00	1.01612	83.00	1.10295	31.00
0.53356	310.00	1.01785	82.00	1.10465	30.00
0.54516	305.00	1.01957	81.00	1.10643	29.00
0.55674	300.00	1.02127	80.00	1.10828	28.00
0.56828	295.00	1.02299	79.00	1.10996	27.00
0.57980	290.00	1.02471	78.00	1.11217	26.00
0.59131	285.00	1.02642	77.00	1.11480	25.00
0.60279	280.00	1.02814	76.00	1.11828	24.00
0.61427	275.00	1.02985	75.00	1.12425	23.00
0.62573	270.00	1.03156	74.00	1.13841	22.00
0.63716	265.00	1.03327	73.00	1.16246	21.00
0.64855	260.00	1.03498	72.00	1.18193	20.00
0.65992	255.00	1.03669	71.00	1.19816	19.00
0.67124	250.00	1.03839	70.00	1.21325	18.00
0.68253	245.00	1.04010	69.00	1.22816	17.00
0.69379	240.00	1.04179	68.00	1.24342	16.00
0.70503	235.00	1.04349	67.00	1.25932	15.00
0.71624	230.00	1.04518	66.00	1.27621	14.00
0.72743	225.00	1.04687	65.00	1.29401	13.00
0.73861	220.00	1.04856	64.00	1.31277	12.00
0.74978	215.00	1.05024	63.00	1.33317	11.00
0.76094	210.00	1.05192	62.00	1.35568	10.00
0.77205	205.00	1.05360	61.00	1.37998	9.00
0.78311	200.00	1.05528	60.00	1.40827	8.00
0.79412	195.00	1.05696	59.00	1.44098	7.00
0.80508	190.00	1.05863	58.00	1.47740	6.00
0.81599	185.00	1.06029	57.00	1.51590	5.00
0.82680	180.00	1.06196	56.00	1.55483	4.00
0.83754	175.00	1.06362	55.00	1.59108	3.00
0.84818	170.00	1.06528	54.00	1.62255	2.00
0.85874	165.00	1.06693	53.00	1.64342	1.00

Cryo-con R500 Ruthenium-Oxide Sensor

The Cryo-con R500 with 10 μ A DC excitation.

Temp(K)	Ohms	Ohms/K	Temp(K)	Ohms	Ohms/K	Temp(K)	Ohms	Ohms/K
20.00	1100.75	-4	0.90	2459.10	-1481	0.45	3762.25	-5877
15.00	1127.06	-7	0.89	2473.91	-1514	0.44	3821.02	-6149
10.00	1178.49	-15	0.88	2489.05	-1548	0.43	3882.51	-6439
9.00	1195.31	-19	0.87	2504.53	-1583	0.42	3946.90	-6751
8.00	1216.12	-24	0.86	2520.36	-1621	0.41	4014.41	-7086
7.00	1242.56	-30	0.85	2536.57	-1658	0.40	4085.27	-7447
6.00	1277.29	-41	0.84	2553.15	-1697	0.39	4159.74	-7837
5.00	1325.01	-58	0.83	2570.12	-1738	0.38	4238.11	-8259
4.50	1356.30	-70	0.82	2587.50	-1781	0.37	4320.70	-8715
4.00	1394.87	-88	0.81	2605.31	-1824	0.36	4407.85	-9212
3.90	1403.69	-93	0.80	2623.55	-1869	0.35	4499.97	-9753
3.80	1412.95	-97	0.79	2642.24	-1917	0.34	4597.50	-10343
3.70	1422.68	-102	0.78	2661.41	-1966	0.33	4700.93	-10989
3.60	1432.91	-108	0.77	2681.07	-2016	0.32	4810.82	-11699
3.50	1443.68	-114	0.76	2701.23	-2070	0.31	4927.81	-12481
3.40	1455.05	-120	0.75	2721.93	-2124	0.30	5052.62	-13345
3.30	1467.06	-127	0.74	2743.17	-2182	0.29	5186.07	-14303
3.20	1479.78	-135	0.73	2764.99	-2242	0.28	5329.10	-15369
3.10	1493.26	-143	0.72	2787.41	-2304	0.27	5482.79	-16562
3.00	1507.58	-152	0.71	2810.45	-2368	0.26	5648.41	-17901
2.90	1522.82	-163	0.70	2834.13	-2436	0.25	5827.42	-19412
2.80	1539.09	-174	0.69	2858.49	-2507	0.24	6021.54	-21126
2.70	1556.48	-186	0.68	2883.56	-2580	0.23	6232.80	-23081
2.60	1575.12	-200	0.67	2909.36	-2658	0.22	6463.61	-25325
2.50	1595.16	-216	0.66	2935.94	-2738	0.21	6716.86	-27920
2.40	1616.77	-234	0.65	2963.32	-2822	0.20	6996.06	-30943
2.30	1640.15	-254	0.64	2991.54	-2911	0.19	7305.49	-34493
2.20	1665.53	-277	0.63	3020.65	-3003	0.18	7650.42	-38706
2.10	1693.20	-303	0.62	3050.68	-3100	0.17	8037.48	-43758
2.00	1723.48	-343	0.61	3081.68	-3202	0.16	8475.06	-49892
1.90	1757.83	-355	0.60	3113.70	-3309	0.15	8973.98	-57444
1.80	1793.33	-396	0.59	3146.79	-3422	0.14	9548.42	-66902
1.70	1832.94	-445	0.58	3181.01	-3540	0.13	10217.44	-78978
1.60	1877.43	-503	0.57	3216.41	-3665	0.12	11007.22	-94764
1.50	1927.75	-574	0.56	3253.06	-3796	0.11	11954.86	-116005
1.40	1985.13	-661	0.55	3291.02	-3935	0.10	13114.91	-145658
1.30	2051.19	-769	0.54	3330.37	-4082	0.09	14571.49	-189096
1.20	2128.07	-906	0.53	3371.19	-4237	0.08	16462.45	-257192
1.10	2218.67	-1084	0.52	3413.56	-4401	0.07	19034.37	-375766
1.00	2327.06	-1203	0.51	3457.57	-4576	0.06	22792.03	-628083
0.99	2339.09	-1226	0.50	3503.33	-4760	0.05	29072.86	
0.98	2351.35	-1251	0.49	3550.93	-4956			
0.97	2363.86	-1277	0.48	3600.49	-5164			
0.96	2376.63	-1303	0.47	3652.13	-5388			
0.95	2389.66	-1331	0.46	3706.01	-5624			
0.94	2402.97	-1359						
0.93	2416.56	-1388						
0.92	2430.44	-1417						
0.91	2444.61	-1449						

Cryo-con R400 Ruthenium-Oxide Sensor

The Cryo-con R400 with 100uV AC excitation.

Temp(K)	Ohms	Ohms/K	Temp(K)	Ohms	Ohms/K	Temp(K)	Ohms	Ohms/K
300.00	1000	-0.08	0.98	2351	-1251.00	0.49	3551	-4956.00
200.00	1008	-0.13	0.97	2364	-1277.00	0.48	3600	-5164.00
100.00	1025	-0.33	0.96	2377	-1303.00	0.47	3652	-5388.00
80.00	1032	-0.49	0.95	2390	-1331.00	0.46	3706	-5624.00
60.00	1042	-0.84	0.94	2403	-1359.00	0.45	3762	-5877.00
40.00	1058	-1.50	0.93	2417	-1388.00	0.44	3821	-6149.00
20.00	1101	-4.08	0.92	2430	-1417.00	0.43	3883	-6439.00
15.00	1127	-7.20	0.91	2445	-1449.00	0.42	3947	-6751.00
10.00	1178	-15.40	0.90	2459	-1481.00	0.41	4014	-7086.00
9.00	1195	-18.80	0.89	2474	-1514.00	0.40	4085	-7447.00
8.00	1216	-23.60	0.88	2489	-1548.00	0.39	4160	-7837.00
7.00	1243	-30.50	0.87	2505	-1583.00	0.38	4238	-8259.00
6.00	1277	-40.90	0.86	2520	-1621.00	0.37	4321	-8715.00
5.00	1325	-57.80	0.85	2537	-1658.00	0.36	4408	-9212.00
4.50	1356	-70.50	0.84	2553	-1697.00	0.35	4500	-9753.00
4.30	1371	-76.90	0.83	2570	-1738.00	0.34	4598	-10343.00
4.20	1378	-80.40	0.82	2588	-1781.00	0.33	4701	-10989.00
4.00	1395	-88.20	0.81	2605	-1824.00	0.32	4811	-11699.00
3.90	1404	-92.60	0.80	2624	-1869.00	0.31	4928	-12481.00
3.80	1413	-97.30	0.79	2642	-1917.00	0.30	5053	-13345.00
3.70	1423	-102.30	0.78	2661	-1966.00	0.29	5186	-14303.00
3.60	1433	-107.70	0.77	2681	-2016.00	0.28	5329	-15369.00
3.50	1444	-113.70	0.76	2701	-2070.00	0.27	5483	-16562.00
3.40	1455	-120.10	0.75	2722	-2124.00	0.26	5648	-17901.00
3.30	1467	-127.20	0.74	2743	-2182.00	0.25	5827	-19412.00
3.20	1480	-134.80	0.73	2765	-2242.00	0.24	6022	-21126.00
3.10	1493	-143.20	0.72	2787	-2304.00	0.23	6233	-23081.00
3.00	1508	-152.40	0.71	2810	-2368.00	0.22	6464	-25325.00
2.90	1523	-162.70	0.70	2834	-2436.00	0.21	6717	-27920.00
2.80	1539	-173.90	0.69	2858	-2507.00	0.20	6996	-30943.00
2.70	1556	-186.40	0.68	2884	-2580.00	0.19	7305	-34493.00
2.60	1575	-200.40	0.67	2909	-2658.00	0.18	7650	-38706.00
2.50	1595	-216.10	0.66	2936	-2738.00	0.17	8037	-43758.00
2.40	1617	-233.80	0.65	2963	-2822.00	0.16	8475	-49892.00
2.30	1640	-253.80	0.64	2992	-2911.00	0.15	8974	-57444.00
2.20	1666	-276.70	0.63	3021	-3003.00	0.14	9548	-66902.00
2.10	1693	-302.80	0.62	3051	-3100.00	0.13	10217	-78978.00
2.00	1723	-343.50	0.61	3082	-3202.00	0.12	11007	-94764.00
1.90	1758	-355.00	0.60	3114	-3309.00	0.11	11955	-116005.00
1.80	1793	-396.10	0.59	3147	-3422.00	0.10	13115	-145658.00
1.70	1833	-444.90	0.58	3181	-3540.00	0.09	14571	-189096.00
1.60	1877	-503.20	0.57	3216	-3665.00	0.08	16462	-257192.00
1.50	1928	-573.80	0.56	3253	-3796.00	0.07	19034	-375766.00
1.40	1985	-660.60	0.55	3291	-3935.00	0.06	22792	-628083.00
1.30	2051	-768.80	0.54	3330	-4082.00	0.05	29073	
1.20	2128	-906.00	0.53	3371	-4237.00			
1.10	2219	-1083.90	0.52	3414	-4401.00			
1.00	2327	-1203.00	0.51	3458	-4576.00			
0.99	2339	-1226.00	0.50	3503	-4760.00			

Sensor Packages

The SM and CP Sensor Packages

The Si430F is mounted in a rugged surface-mounted package. This compact package features a low thermal mass and is easy to install.

Package material is gold plated OHFC copper on an Alumina substrate. Solder limits the temperature range to 400K.

Leads are 3 inches, material is 37 AWG copper with Polyimide insulation. Positive connection is Red and negative is Black.

Sensor is easily installed by attaching the substrate directly to the desired surface using cryogenic varnish. Leads should be thermally anchored.

The Cap is ultra-compact and features low thermal mass and operation to 500K.

Package material is gold plated OHFC copper.

Leads are 3 inches. Material is 37 AWG copper with Polyimide insulation. Positive connection is Red and negative is Black.

This package is extremely small and has a low thermal mass.

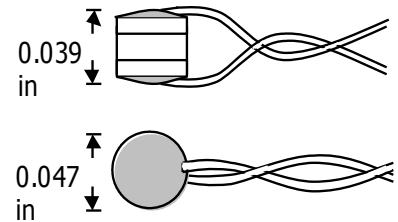
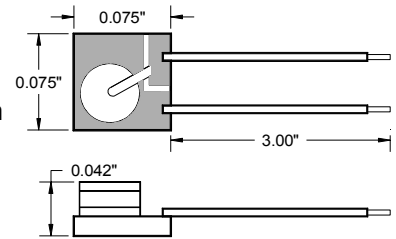
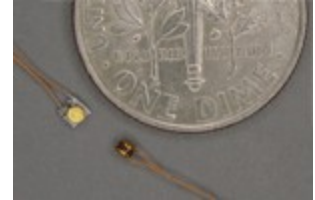

The Model 21 Sensor Package

The Model 21 package is an industry standard 0.310" bobbin package that features excellent thermal contact to the internal sensing element. This ensures a rapid thermal response and minimizes thermal gradients between the sensing element and the sensor package. Mechanical integrity of the sensor assures reliable performance even in severe applications.

With the bobbin package, the lead wires are thermally anchored to the sensor mounting. This is essential for accurate sensor readings.

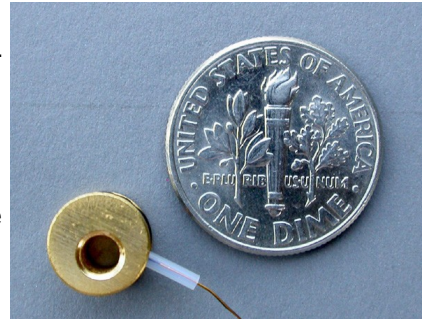

Bobbin Package Specifications	
Bobbin Material	Gold plated Oxygen free hard Copper.
Marking	Individual serial number.
Sensor Bonding	Stycast® epoxy.
Mass	1.1g excluding leads.
Leads	36 inches, 36AWG Phosphor-Bronze. Four-lead color coded cryogenic ribbon cable. Insulation is heavy Formvar® .
Mounting	4-40 machine screw.
Temperature	400K Maximum.

Table 15: BB Package Specifications

Cable Color Codes	
V+	Clear
V-	Green
I+	Black
I-	Red

Table 16: Cable Color Code

Connections to the package are made using a color-coded four-wire, 36 AWG cryogenic ribbon cable.

Wires may be separated by dipping in Isopropyl Alcohol and then wiping clean.

Insulation is Polyimide and is difficult to strip. Techniques include use of a mechanical stripper, scrapping with a razor blade and passing the wire quickly over a low flame.

The package is easily mounted with a #4-40 brass screw. A brass screw is recommended because thermal stress will be reduced at cryogenic temperature.

The mounting surface should be clean. A rinse with Isopropyl Alcohol is recommended.

First, apply a small amount of Apiezon™ N grease to the threads of the screw and on the mounting surface of the sensor package.

Next, place the bobbin on the mounting surface, insert screw through bobbin and lightly tighten.

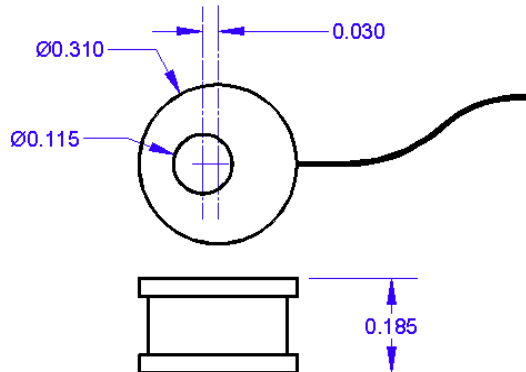

The Canister Sensor Package

Ruthenium-Oxide sensors are available in a small 0.095" x 0.2" cylindrical canister package.

Construction: Gold-plated cylindrical OHFC copper canister, Stycast® epoxy filler. There is no internal atmosphere. Epoxy limits the maximum storage temperature to 400K.

Leads: Four, 36 AWG, Phosphor-Bronze, color coded. Formvar® insulation.

Mass: 0.4g.

Installation: Use a 0.101" diameter drill. Place a small amount of Apiezon® N grease in the hole before inserting the sensor. Ensure that the leads are thermally anchored.



Cable Color Code	
V+	Clear
V-	Green
I+	Black
I-	Red

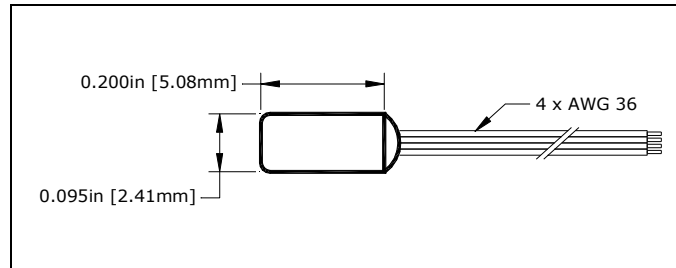

Connection:

All connections should be 4-wire in order to eliminate errors due to lead resistance.

Leads are coated with Butyl and may be separated by dipping them in Isopropyl Alcohol.

Lead insulation is heavy Polyimide which is difficult to strip. Techniques include use of a mechanical stripper or scrapping with a razor blade.

Appendix F: Configuration Scripts

The Utility software package can be used to send configuration scripts to an instrument. These scripts consist mostly of standard remote commands and queries.

Scripts can be used to completely configure an instrument including setting custom sensor calibration curves and PID tables. They are commonly used in a manufacturing environment to set a baseline state for a target product. In the laboratory, scripts can be used to save and restore configurations for various experiments.

XML, or Extensible Markup Language, is used for the structure and format of script files. XML can be generated and edited with a standard text editor but advanced users may want to use one of the commonly available XML editors. Since it provides a structure and allows user documentation, it is easy to read and understand.

Configuration scripts have a file extension of .xml. These files are sent to an instrument by using the Operations->Send Command File function of the Utility Software.

Any remote command or query that is recognized by the instrument can be used in a script file. This includes commands that read and write user sensor calibration curves and PID tables. A complete description of available remote commands is given in the chapter titled [Remote Programming Guide](#). The Remote Command Tree section is particularly useful for the advanced user.

Script File Structure

Header and Footer

Like all XML files, script files have the following header and footer:

```
<?xml version="1.0"?>
<Transactions>
.
.
.
</Transactions>
```

All user supplied information is placed between the Transactions tags.

Basic XML Tags

Comment: <! >

Inserts a comment in the file for documentation and readability. The comment within the angle brackets after the exclamation is ignored by the software.

```
<!Download User Curve 4>
<!------- Loop 1 ----->
```

Model: <Model> </Model>

Contains the instrument model number for source/destination verification.

```
<Model>Model9308 Version 2.03</Model>
```

Remote Command: <Command> </Command>

Send a remote command to the instrument. Commands can be any of the instrument's commands as described in the [Remote Programming Guide](#).

```
<Command>input c:sensor 2</Command>
<Command>LOOP 1:SOURCE A;Setpt 20.0</Command>
<Command>OVERTEMP:ENABLE ON</Command>
```

Query: <Query> </Query>

Query data from the instrument. Queries can be any of the instrument's commands as described in the [Remote Programming Guide](#). Query is generally used with a Response tag to compare the instrument's response to an expected value. If there is no Response tag, the result of the query is printed but not tested for errors.

```
<Query>input c:sensor?</Query>
<Query>input b:units K;units?</Query>
```

Response: <Response> </Response>

Identifies the expected response to a query. This tag must always follow a Query tag, otherwise, it is ignored. When the comparison fails, an error text message will be displayed and recorded to a file.

```
<Query>Relays? 0</Query>
<Response>Lo</Response>

<Query>input c:units?</Query>
<Response>K</Response>    <! Should be Kelvin. Error if not >
```

Floating Point Response: <Floatresponse> </Floatresponse>

Compare the response returned from the instrument against an expected floating point number. This tag must always follow a Query tag; otherwise, it is ignored. When the comparison fails, an error text message will display. The returned value passes the test if within +/-2.5% of the expected value.

```
<Query>input a:ALAR:High?</Query>
<FloatResponse>200.000000</FloatResponse>
```

Pause: <Pause> </Pause>

Provide a pause for a specified number of milliseconds to allow the instrument to react to a command. Maximum 20 seconds. Generally, this is only used with the RS-232 serial interface where there is no hardware handshake.

```
<Pause>1000</Pause> <! Delay 1 second >
```

Group Tags

Any tag that is not defined is treated as a group tag. They are used to provide structure and enhance readability. Otherwise, they are ignored.

Complex Tags

Sending a user sensor calibration curve or a PID table to an instrument requires a complex tag because it can require many lines of data.

User Sensor Calibration Curve: <Calcur>

Send a sensor calibration curve to the instrument.

```
<!Download User curve 4>
<CalCur>Calcur 4</CalCur>
<!--Curve Name-->
  <CalCur>My Sensor</CalCur>
<!--Curve Type-->
  <CalCur>Diode</CalCur>
<!--Multiplier-->
  <CalCur>-1.000000</CalCur>
<!--Units-->
  <CalCur>Volts</CalCur>
<!--Curve Entries-->
  <CalCur>0.163300 475.000000</CalCur>
  <CalCur>0.173300 470.000000</CalCur>
  <CalCur>0.183400 465.000000</CalCur>
  <CalCur>1.866000 1.500000</CalCur>
<!--Send the terminator character-->
<CalCur>;</CalCur>
```

Transmission of the calibration curve starts with the first CALCUR tag and ends when the terminator character is sent. Comments are ignored.

Script File Example

```
<?xml version="1.0"?>
<Transactions>
  <Model>Model9304 Version 3.06</Model>
  <Input>
    <!-- CHA -->
    <Command>input a:sensor 20</Command> <! Set to PT100>
    <Query>input a:temp?</Query>
    <Command>input a:sensor 21</Command> <! Set to PT1K>
    <Query>input a:temp?</Query> <! Ignore response>

    <!-- CHB -->
    <Command>input b:sensor 20</Command>
    <Query>input b:temp?</Query>
    <Response>K</Response>
    <Command>input b:sensor 21</Command>
    <Query>input b:temp?</Query>
  </Input>
  <SensorCurve>
    <!User curve 4>
    <CalCur>CALCUR 4</CalCur>
    <!Curve Name>
    <CalCur>Test Si430</CalCur>
    <!Curve Type>
    <CalCur>Diode</CalCur>
    <!Multiplier>
    <CalCur>-1.000000</CalCur>
    <!Unit>
    <CalCur>Volts</CalCur>
    <!Curve Entries>
    <CalCur>0.163300 475.000000</CalCur>
    <CalCur>0.173300 470.000000</CalCur>
    <CalCur>0.183400 465.000000</CalCur>
    <CalCur>0.193500 460.000000</CalCur>
    <CalCur>0.203800 455.000000</CalCur>
    <CalCur>0.214100 450.000000</CalCur>
    <CalCur>0.224600 445.000000</CalCur>
    <CalCur>0.235100 440.000000</CalCur>
    <CalCur>0.245800 435.000000</CalCur>
    <CalCur>0.256500 430.000000</CalCur>
    <CalCur>0.267300 425.000000</CalCur>
    <CalCur>0.278100 420.000000</CalCur>
    <CalCur>0.289100 415.000000</CalCur>
    <CalCur>0.300100 410.000000</CalCur>
    <CalCur>0.311100 405.000000</CalCur>
    <CalCur>0.322200 400.000000</CalCur>
    <CalCur>0.333400 395.000000</CalCur>
    <CalCur>0.344600 390.000000</CalCur>
    <CalCur>0.355800 385.000000</CalCur>
    <CalCur>;</CalCur>
  </SensorCurve>
</Transactions>
```

Appendix G: Sensor Data Tables

Silicon Diode

Silicon diode sensors offer good sensitivity over a wide temperature range and are reasonably interchangeable.

Use in magnetic fields is not recommended.

Silicon diode sensors use a constant-current DC excitation of 10 μ A.

Cryo-con S900 Silicon Diode		
Name: Cryocon S900 Configuration: Diode		
T(K)	Volts	mV/K
1.4	1.63864	-36.56
4.2	1.53960	-33.91
10	1.35568	-26.04
20	1.18193	-11.34
30	1.10465	-3.12
50	1.07188	-1.46
77.35	1.02511	-1.69
100	0.98615	-1.85
150	0.88988	-2.03
200	0.78311	-2.17
250	0.67124	-2.28
300	0.55674	-2.36
355	0.42759	-2.33
400	0.32161	-2.38
450	0.20231	-2.37
500	0.09077	-2.12

Cryo-con S800 Silicon Diode		
Name: Cryocon S800 Configuration: Diode		
T(K)	Volts	mV/K
1.4	1.87515	-36.86
4.2	1.75099	-49.16
10	1.47130	-43.45
20	1.18867	-15.93
30	1.10594	-3.90
50	1.07079	-1.47
77.35	1.02356	-1.86
100	0.98170	-1.85
150	0.88365	-2.03
200	0.77887	-2.13
250	0.67067	-2.20
300	0.55955	-2.22
355	0.44124	-2.10
385	0.37611	-2.26

Scientific Instruments SI-430 and SI-440		
Name: SI 430 Diode Configuration: Diode		
Name: SI 440 Diode Configuration: Diode		
T(K)	Volts	mV/K
1.4	1.63864	-36.56
4.2	1.53960	-33.91
10	1.36317	-26.04
20	1.17370	-11.34
30	1.10343	-3.12
50	1.07399	-1.46
77.35	1.02511	-1.69
100	0.98740	-1.85
150	0.89011	-2.03
200	0.78272	-2.17
250	0.67085	-2.28
300	0.55665	-2.36
355	0.42759	-2.33
400	0.32161	-2.38
450	0.20231	-2.37
500	0.09077	-2.12

Scientific Instruments SI-410		
Name: SI 410 Diode Configuration: Diode		
T(K)	Volts	mV/K
1.4	1.71488	-10.54
4.2	1.64660	-32.13
10	1.39562	-35.28
20	1.17592	-20.43
30	1.10136	-1.75
50	1.06957	-1.59
77.35	1.14905	-1.72
100	0.98322	-1.82
150	0.88603	-2.00
200	0.78059	-2.14
250	0.67023	-2.23
300	0.55672	-2.28
350	0.44105	-2.32
400	0.32319	-2.36
450	0.20429	-2.38

Lakeshore DT-670 Silicon Diode		
Name: LS DT-670		Configuration: Diode
T(K)	Volts	mV/K
1.4	1.64429	-12.49
4.2	1.57848	-31.59
10	1.38373	-26.84
20	1.19775	-15.63
30	1.10624	-1.96
50	1.07310	-1.61
77.35	1.02759	-1.73
100	0.98697	-1.85
150	0.88911	-2.05
200	0.78372	-2.16
250	0.67346	-2.24
300	0.55964	-2.30
350	0.44337	-2.34
400	0.32584	-2.36
450	0.20676	-2.39
500	0.09068	-2.12

Lakeshore DT-470 Silicon Diode		
Name: LS DT-470		Configuration: Diode
T(K)	Volts	mV/K
1.4	1.6981	-13.1
4.2	1.6260	-33.6
10	1.4201	-28.7
20	1.2144	-17.6
30	1.1070	-2.34
50	1.0705	-1.75
77.35	1.0203	-1.92
100	0.9755	-2.04
150	0.8687	-2.19
200	0.7555	-2.31
250	0.6384	-2.37
300	0.5189	-2.4
350	0.3978	-2.44
400	0.2746	-2.49
450	0.1499	-2.46
475	0.0906	-2.22

GaAlAs Diode

GaAlAs diode sensors offer good sensitivity over a wide range of temperatures. However, they do not follow a standard calibration curve.

Useful in magnetic fields below 5T and a temperature above 30K. Outside of this range, a Ruthenium-Oxide sensor offers better performance.

GaAlAs diode sensors use a constant-current DC excitation of 10 μ A. The Model 9308 limits low temperature operation to 25K since that is outside of the limits for use in magnetic fields.

Shaded entries are outside of the Model 9308's temperature range.

Lakeshore TG-120 GaAlAs Diode		
Name: User Supplied		Configuration: Diode
T(K)	Volts	mV/K
1.4	5.3909	-97.5
4.2	4.7651	-214
10	3.7521	-148
20	2.5341	-97.5
30	1.8056	-48.2
50	1.4637	-2.82
77.35	1.4222	-1.24
100	1.3918	-1.48
150	1.2985	-2.25
200	1.1738	-2.64
250	1.0383	-2.77
300	0.8978	-2.85
350	0.7531	-2.99
400	0.6066	-2.97
450	0.4556	-3.08
475	0.3778	-3.15

Platinum RTD

Platinum RTD sensors feature high stability, low magnetic field dependence and excellent interchangeability. They conform to the DIN43760 standard curve.

The Model 9308 uses 1.0mA Constant-Current AC excitation.

Platinum RTD, DIN43760 and IEC751		
Name: Pt100 385	Configuration: PTC100	
Name: Pt1K 385	Configuration: PTC1K	
Name: Pt10K 385	Configuration: PTC10K	
T(K)	Ohms	Ω/K
20	2.2913	0.085
30	3.6596	0.191
50	9.3865	0.360
77.35	20.380	0.423
100	29.989	0.423
150	50.788	0.409
200	71.011	0.400
250	90.845	0.393
300	110.354	0.387
400	148.640	0.383
500	185.668	0.378
600	221.535	0.372
700	256.243	0.366
800	289.789	0.360
900	324.302	0.318
1123	390.47	0.293

Rhodium-Iron

Rhodium-Iron sensors feature high stability, low magnetic field dependence and reasonable interchangeability.

The Model 9308 supports them with 1.0mA Constant-Current AC excitation.

Rhodium-Iron 27 Ω		
Name: RhFe 27 1mA Configuration: PTC100		
T(K)	Ohms	Ω/K
1.4	1.5204	0.178
4.2	1.9577	0.135
10	2.5634	0.081
20	3.1632	0.046
30	3.5786	0.040
50	4.5902	0.064
77.4	6.8341	0.096
100	9.1375	0.106
150	14.463	0.105
200	19.641	0.102
250	24.686	0.101
300	29.697	0.101
350	34.731	0.101
400	39.824	0.103

Cernox™

Cernox™ temperature sensors do not follow a standard calibration curve. Data shown here is for typical sensors.

The Model 9308 supports Cernox™ using a 1.0mV or less Constant-Voltage AC excitation. This extends low temperature operation to 100mK. Please refer to the section titled "[Selecting a Voltage Bias for NTC Sensors](#)"

Lakeshore Cernox™ CX-1010		
Name: User Supplied		Config: ACR 1.0mV
T(K)	Ohms	Ω/K
0.1	21389	-558110
0.2	4401.6	-38756
0.3	2322.4	-10788
0.4	1604.7	-4765.9
0.5	1248.2	-2665.2
1	662.43	-514.88
1.4	518.97	-251.77
2	413.26	-124.05
3	328.95	-58.036
4.2	277.32	-32.209
6	234.44	-17.816
10	187.11	-8.063
20	138.79	-3.057
30	115.38	-1.819
40	100.32	-1.252
50	89.551	-0.929
77.35	70.837	-0.510
100	61.180	-0.358
150	47.782	-0.202
200	39.666	-0.130
250	34.236	-0.090
300	30.392	-0.065

Lakeshore Cernox™ CX-1030		
Name: User Supplied		Config: ACR 10mV
T(K)	Ohms	Ω/K
0.3	31312	-357490
0.4	13507	-89651
0.5	7855.7	-34613
1	2355.1	-3265.2
1.4	1540.1	-1264.9
2	1058.4	-509.26
3	740.78	-199.11
4.2	574.20	-97.344
6	451.41	-48.174
10	331.67	-19.042
20	225.19	-6.258
30	179.12	-3.453
40	151.29	-2.249
50	132.34	-1.601
77.35	101.16	-0.820
100	85.940	-0.552
150	65.864	-0.295
200	54.228	-0.184
250	46.664	-0.124
300	41.420	-0.088
350	37.621	-0.065
400	34.779	-0.050
420	33.839	-0.045

Lakeshore Cernox™ CX-1050		
Name: User Supplied		Config: ACR 10mV
T(K)	Ohms	Ω/K
1.4	26566	-48449
2	11844	-11916
3	5733.4	-3042.4
4.2	3507.2	-1120.8
6	2252.9	-432.14
10	1313.5	-128.58
20	692.81	-30.871
30	482.88	-14.373
40	373.11	-8.392
50	305.19	-5.507
77.35	205.67	-2.412
100	162.81	-1.488
150	112.05	-0.693
200	85.800	-0.397
250	69.931	-0.253
300	59.467	-0.173
350	52.142	-0.124
400	46.782	-0.093
420	45.030	-0.089

Model 9308, 9304 and 9302 Temperature Monitors
Appendix G: Sensor Data Tables

Lakeshore Cernox™ CX-1070		
Name: User Supplied		Config: ACR 100mV
T(K)	Ohms	Ω/K
4.2	5979.4	-2225.3
6	3577.5	-794.30
10	1927.2	-214.11
20	938.93	-46.553
30	629.90	-20.613
40	474.89	-11.663
50	381.42	-7.490
77.35	248.66	-3.150
100	193.29	-1.899
150	129.60	-0.854
200	97.626	-0.477
250	78.723	-0.299
300	66.441	-0.201
350	57.955	-0.143
400	51.815	-0.106
420	49.819	-0.094

Lakeshore Cernox™ CX-1080		
Name: User Supplied		Config: ACR 100mV
T(K)	Ohms	Ω/K
20	6157.5	-480.08
30	3319.7	-165.61
40	2167.6	-79.551
50	1565.3	-45.401
77.35	836.52	-15.398
100	581.14	-8.213
150	328.75	-3.057
200	220.93	-1.506
250	163.73	-0.863
300	129.39	-0.545
350	106.98	-0.368
400	91.463	-0.261
420	86.550	-0.231

Ruthenium-Oxide

Cryo-con R500

The R500 Ruthenium-Oxide temperature sensor is designed primarily for ultra-low temperature operation. Features include interchangeability and operation in high magnetic fields.

The Model 9308 will support the R500 down to <200mK. Please refer to the section titled "[Selecting a Voltage Bias for NTC Sensors](#)"

Cryo-Con R500 Ruthenium-Oxide		
Name: Cryocon R500		Config: ACR 1.0V
T(K)	Ohms	Ω/K
0.05	29072	-628083
0.1	13114	-145658
0.2	6996	-30943
0.3	5053	-13345
0.5	3503	-4760
1	2327	-1203
1.4	1985	-660.6
2	1723	-343.5
3	1508	-152.4
4.2	1378	-80.4
6	1277	-40.9
10	1178	-15.4
20	1101	-4.08
30	1053	-4.0
40	1009	-3.5

Cryo-con R400

The R400 Ruthenium-Oxide temperature sensor is designed for operation between 2.0K and 273K with high sensitivity below 40K. They feature interchangeability and operation in high magnetic fields.

Applications include low temperature superconducting magnet systems and liquid helium systems.

Using the NTC10uA input configuration will operate with the R400 over it's full temperature range.

Cryo-Con R400 Ruthenium-Oxide		
Name: Cryocon R400 Config: NTC10uA		
T(K)	Ohms	Ω/K
2	239556	-17787
3	221769	-13961
4	207807	-11343
6	187171	-7647
10	163317	-3907
20	138709	-1400
30	128199	-745
40	122128	-474
100	108595	-108
200	102432	-34
273	100604	-0.05

Scientific Instruments RO-600		
Name: SI RO-600		Config: ACR 1.0mV
T(K)	Ohms	Ω/K
0.05	29072	-628083
0.1	13114	-145658
0.2	6996	-30943
0.3	5053	-13345
0.5	3503	-4760
1	2327	-1203
1.4	1985	-660.6
2	1723	-343.5
3	1508	-152.4
4.2	1378	-80.4
6	1277	-40.9
10	1178	-15.4
20	1101	-4.08
30	1053	-4.0
40	1009	-3.5

Scientific Instruments RO-105		
Name: SI RO-105		Config: NTC10uA
T(K)	Ohms	Ω/K
2	239556	-17787
3	221769	-13961
4	207807	-11343
6	187171	-7647
10	163317	-3907
20	138709	-1400
30	128199	-745
40	122128	-474
100	108595	-108
200	102432	-34
273	100604	-0.05

Model 9308, 9304 and 9302 Temperature Monitors
Appendix G: Sensor Data Tables

Thermocouples

An external thermocouple module is required.

Thermocouple Type E		
Name: TC type E		Config: TC70
K	μV	$\mu\text{V/K}$
3.2	-9834.9	1.59
4.2	-9833	2.09
10	-9813.3	4.66
20	-9747	8.51
30	-9643.8	12.1
40	-9505.5	15.5
50	-9334.2	18.7
75	-8777.7	25.6
100	-8063.4	31.4
150	-6238.1	41.2
200	-3967.4	49.3
250	-1328.7	56
273.15	0	58.5
300	1608	61.1
350	4777.7	65.6
400	8159.8	69.6
500	15426	75.3
600	23138	78.6
670	28694	80
700	31100	80.4
800	39179	81
900	47256	80.4
1000	55247	79.3
1100	63119	78.1
1200	70842	76.3
1270	76136	75.2

Thermocouple Type K		
Name: TC type K		Config: TC70
K	μV	$\mu\text{V/K}$
3.2	-6457.7	0.74
4.2	-6456.9	0.92
10	-6448.5	2.01
10.5	-6447.4	2.12
20	-6417.8	4.15
30	-6365.1	6.39
40	-6290	8.61
50	-6193.3	10.7
75	-5862.9	15.6
100	-5417.6	19.9
150	-4225.5	27.5
200	-2692.8	33.5
250	-897.6	38
273.15	0	39.4
300	1075.3	40.6
350	3135.8	41.5
400	5200	40.8
500	9215.6	40.3
600	13325	41.7
670	16264	42.2
700	17533	42.4
800	21789	42.6
900	26045	42.4
1000	30251	41.7
1100	34373	40.7
1200	38396	39.7
1270	41153	39
1300	42318	38.7
1400	46131	37.5
1500	49813	36.1
1600	53343	34.5
1640	54712	34

Model 9308, 9304 and 9302 Temperature Monitors
 Appendix G: Sensor Data Tables

Thermocouple Type T Name: TC type T Config: TC70			Thermocouple Type Chromel-AuFe(0.07%) Name: AuFe 0.07% Config: TC70		
K	μV	$\mu V/K$	K	μV	$\mu V/K$
3.2	-6257.5	1.03	1.2	-5299.6	8.98
4.2	-6256.2	1.4	2	-5292	10.1
10	-6242.9	3.12	3.2	-5278.9	11.6
20	-6199.2	5.58	4.2	-5266.8	12.6
30	-6131.3	7.99	10	-5181.8	16
40	-6040	10.2	20	-5014	17
50	-5927.7	12.2	30	-4846.4	16.6
75	-5573.6	16	40	-4681.5	16.5
100	-5131.2	19.4	50	-4515.8	16.7
150	-4004.3	25.6	75	-4084.6	17.8
200	-2575.3	31.4	100	-3627	18.8
250	-872.57	38	150	-2645.2	20.4
273.15	0	39.4	200	-1600.1	21.4
300	1067.4	40.8	250	-512.81	22
350	3215.5	45	300	597.44	22.4
400	5560.2	48.7	350	1696.3	21.8
500	10735	54.6	400	2805.7	22.7
600	16437	59.2	500	5135.3	23.4
670	20677	61.7	600	7470.7	23.4

Appendix H: Rear Panel Connections

Rear Panel

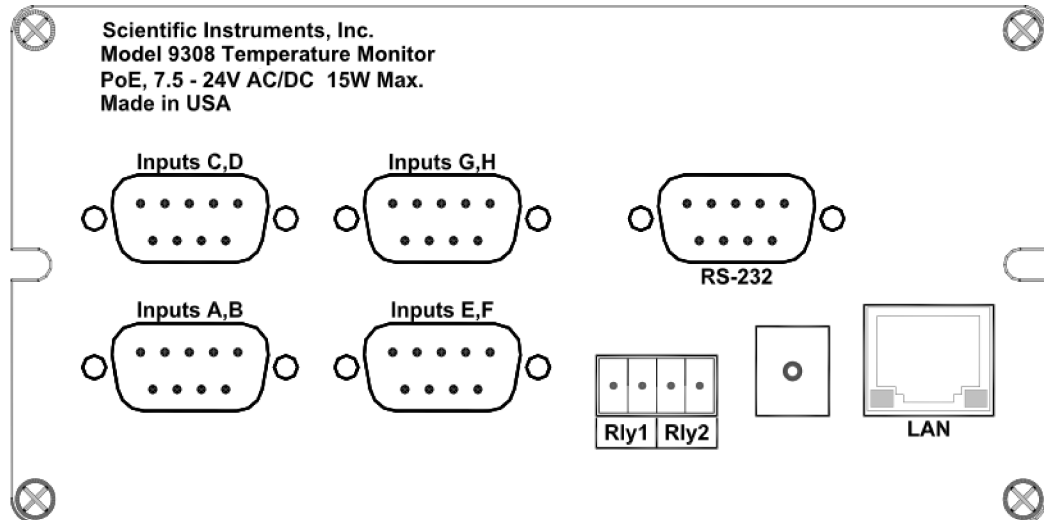

Figure 2: Model 9308 Rear Panel

Input Connectors

Four DB-9 receptacles provide 4-wire measurement for two sensors each. The Model 9302 has one connector. The Model 9304 has two and the Model 9308 has four. Any input connector can also be used for the dual thermocouple option connection.

LAN

A standard RJ-45 Ethernet connector is used for connection to a local area network. This connector is also used for the Power-over-Ethernet connection.

If the GPIB option is used, the LAN connector connects the option to the instrument.

Power input

Power jack for an external power supply. Input is 7.5 to 48 Volts AC or DC, 10W. Jack is 2.1mm with positive voltage on the center and negative on the sleeve.

Normally connects to the supplied external power supply.

Note: Instrument power may be connected to the power jack. Alternatively, power may be supplied to the LAN connector by using a Power-Over-Ethernet powered hub or power injector. It is not damaging, but not useful to power both connectors as the instrument will just select the highest voltage.

RS-232

DB9 null-modem connection. This connector is also used for the USB serial port emulator option.

Relays

A four pin, 3.5mm, detachable terminal block is used to connect to the Normally-Open contacts of the two relays. Contact ratings: 10A@125 VAC, 5A@250VAC or 5A@30VDC.

Sensor Connections

All four sensor connections are made at the rear panel of the Model 9308 using the two DB-9 receptacles provided. There are two channels on each connector.

Four Wire Sensor Connections

Silicon Diode and all resistor type sensors should be connected to the Model 9308 using the four-wire method. It is strongly recommended that sensors be connected using shielded, twisted pair wire. Cable shields should be dressed for connection to the conductive backshell of the connector. Signal connection is as follows:

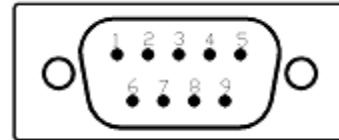

Figure 3: Input Connector

Input Channel	Signal	Pin
A	Excitation Current(+)	8
A	Excitation Current(-), Signal Ground.	9
A	Voltage Sense(+)	4
A	Voltage Sense(-)	5
B	Excitation Current(+)	6
B	Excitation Current(-), Signal Ground.	7
B	Voltage Sense(+)	1
B	Voltage Sense(-)	2
	Option power. 5VDC@500mA	3

Table 17: Sensor Input Connector Pinout



Caution: To ensure proper low noise operation, cable shields should be connected to the metal backshell of the connector. Please refer to the section on shielding and grounding for further information.



Caution: Pin 3 of each input connector is used to power external options such as the dual thermocouple module. If there is no option present, this pin should be left unconnected.

Note: Since power supplied to the instrument does not generally provide an earth ground reference, this reference is often established by connecting the sensor cable shield to the instrument's chassis on one end and to the cryostat ground on the other. Generally, these connections are made using the backshell on the connectors.

Color codes for the Dual Sensor Cable (part number 402-015) are as follows:

Input Channel	Color Code	Signal	Pin
ChA	White	Current(+)	8
ChA	Green	Current(-)	9
ChA	Red	Sense(+)	4
ChA	Black	Sense(-)	5
ChB	White	Current(+)	6
ChB	Green	Current(-)	7
ChB	Red	Sense(+)	1
ChB	Black	Sense(-)	2

Table 18: Dual Sensor Cable Color Codes

The cable used is Belden 8723. This is a dual twisted pair cable with individual shields and a drain wire. The shields and drain wire are connected to the DB9 connector's metal backshell in order to complete the shielding connection.

Sensor Wiring

DC offsets can build up in cryogenic temperature measurement systems due to thermocouple effects within the sensor wiring. They are commonly referred to as Thermal EMFs. Careful wiring can minimize these effects.

The most effective method of minimizing thermocouple (DC) offsets is to wire temperature sensors so that connections between dissimilar metals are grouped together. For example, the connection between sensor leads and cryostat wiring should be kept close together. This way, the thermocouple junctions formed by the connection will have equal-but-opposite voltages and will cancel each other.

Frequently, sensor leads are made from the same material as the cryostat wires. Therefore, there is no significant thermocouple formed by this connection.

In a four-wire measurement scheme, only connections in the voltage sense lines can cause measurement errors. So, the sense wires should have adjacent contacts in a multi-pin connector in order to minimize any temperature difference between them.



Caution: Any disconnected inputs to the Model 9308 should be configured to a sensor type of 'None'. This will turn the input off and prevent the high-impedance preamplifiers from drifting into a latch-up state.

Recommended color codes for a sensor cable are as follows:

Color Code	Signal	Pin
White	Excitation(+)	5
Green	Excitation(-)	1
Red	Sense(+)	4
Black	Sense(-)	2

Table 19: Sensor Cable Color Codes

The cable used is Belden 8723. This is a dual twisted pair cable with individual shields and a drain wire. The shields and drain wire are connected to the connector's metal backshell in order to complete the shielding connection.

A four-wire connection is recommended in order to eliminate errors due to lead resistance. Cryogenic applications often use fine wires made from specialty metals that have low heat conduction. This results in high electrical resistance and, therefore, large measurement errors if the four-wire scheme is not used.

Four-wire connection to diode and resistive type sensors is diagrammed below:

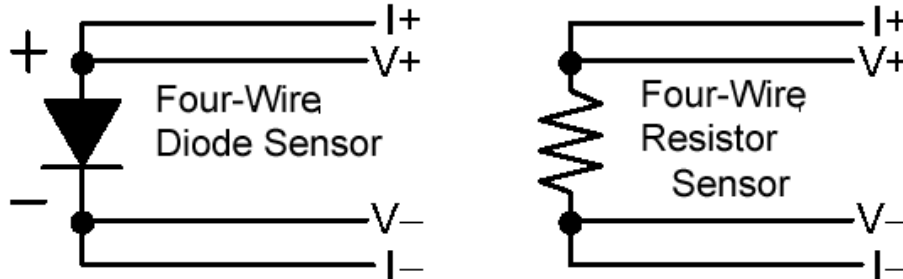

Figure 4: Diode and Resistor Sensor Connections

Thermocouple connections

Thermocouple sensors require the use of an external thermocouple module option. All thermocouple connections must be made at the module's input connector since this connector is thermally anchored to an internal sensor that is used for Cold Junction compensation.

Sensor connection is made at the screw terminals. Proper polarity of the sensor wires is required. Polarity is marked on the input connector and a summary of common thermocouple polarities is given in the table below. The input connector should have its plastic back-shell and rubber grommet installed in order to prevent local air currents from generating errors in the cold junction circuitry.

It is recommended that the thermocouple sensor be electrically isolated, or floating, from any surrounding circuits or grounds. This will ensure the highest possible measurement accuracy.

Additional discussion on thermocouple and grounding issues can be found below in the ["Using Thermocouple Sensors"](#) section below.

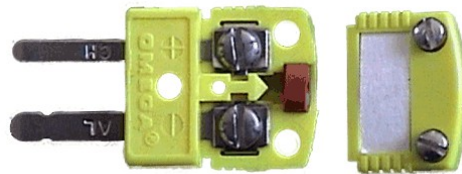

Type	(+) Terminal	(-)Terminal
E	Chrome, Purple	Constantan, Red
K	Chrome, Yellow	Aluminum, Red
T	Copper, Blue	Constantan, Red
Chromel-AuFe	Chromel, Silver	Gold, Gold

Table 20: Thermocouple Polarities

Relay Connections

Relay connections are made on the rear panel using the 3.5mm, 4-pin detachable terminal block provided.

Pin	Function
1	Relay #1 N.O.
2	Relay #1 Common.
3	Relay #2 N.O.
4	Relay #2 Common.

Table 21: Relay Connections

Terminal block contacts are rated at 10.0A. Relay contact ratings are 10A@125 VAC, 5A@250VAC or 5A@30VDC.

Ethernet (LAN) Connection

The 10/100-BaseT Ethernet network (RJ-45) system is used by the Model 9308 for Ethernet network connectivity. The 10/100 Mbps twisted-pair Ethernet system operates over two pairs of wires. One pair is used for receiving data signals and the other pair is used for transmitting data signals. This means that four pins of the eight-pin connector are used.

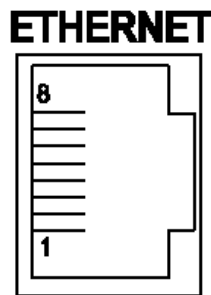

Pin	Name	Description
1	+Tx	+ Transmit Data
2	-Tx	- Transmit Data
3	+RX	+ Receive Data
4	N/C	Not Connected
5	N/C	Not Connected
6	-Rx	- Receive Data
7	N/C	Not Connected
8	N/C	Not Connected

Figure 5: LAN RJ-45 Pinout

10/100-BaseT Straight Through (Patch) Cable

When connecting the Model 9308 to a hub or switch, a standard Category 5 'patch' cable is used. This connects the instrument's transmit lines to the hub's receive lines etc.

10/100-BaseT Crossover Cable

When connecting the Model 9308 directly to the computer, the transmit data pins of the computer should be wired to the receive data pins of the Model 9308, and vice a verse. The 10/100-BaseT **crossover cable** should be used for this purpose. A crossover cable is usually a different color than the straight through patch cable.

Power-Over-Ethernet Connection

The instrument may be powered by an IEEE-802.3at Power-Over-Ethernet compatible powered hub or power injector. When connected to the RJ-45 input, the instrument will negotiate power requirements with the hub and then power itself from the Ethernet cable. Since power and data are taken from a single cable, wiring can be simplified.

Power-Over-Ethernet supplies are NOT earth ground referenced. Some other connection between the instrument's chassis and earth ground should be fabricated in order to minimize noise coupling.

IEEE-488.2 Connections

The optional IEEE-488.2 (GPIB) connection is installed by connecting the dongle to the Ethernet port using the crossover LAN cable provided. The interface will be configured by the instrument and will appear to your system as a standard IEEE-488.2 device.

RS-232 Connections

The Model 9308 uses a Female DB-9 connector for RS-232 serial communications. The pin-out of this connector is as follows:

Pin	Function	Pin	Function
1	NC	6	NC
2	RXD, Receive data	7	NC
3	TXD, Transmit data	8	NC
4	NC	9	NC
5	Ground		

Table 22: RS-232 DB-9 Connector Pinout

The cable used to connect the Model 9308 to a computer serial port is a Dual Female Null Modem cable. An example is Digikey Inc. part number AE1033-ND.

The wiring diagram for this cable is shown below. Note that communication with the Model 9308 only requires connection of pins 2, 3 and 5. All other connections are optional.

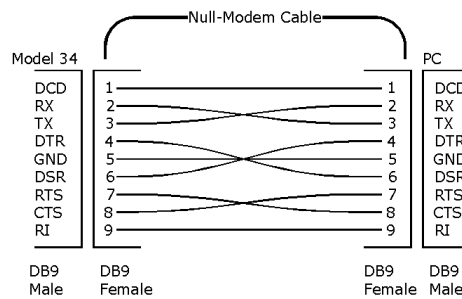

Figure 6: RS-232 Null Modem Cable

INDEX

AC power.....	Factory Defaults.....
Single-Point-Ground.....	restoring.....
37	10
Accessories.....	Firmware Revision Level.....
6	5
Alarms.....	Firmware Update Utility.....
clearing.....	FWutility.exe.....
26	83
enable.....	introduction.....
25	83
hysteresis.....	Hardware Revision Level.....
26	5
latched.....	IEEE-488.....
10, 26	address.....
LED.....	66
9	Configuration.....
low temperature.....	55
25	connection.....
setpoint.....	116
25	GPIB.....
visual.....	55
13	specifications.....
CalGen@.....	19
11, 18	Input Channel.....
Configuration Scripts.....	alarm outputs.....
99	19
Command tag.....	audible alarm.....
99	19
Comment tag.....	Input Protection.....
99	11, 18
Complex tags.....	Instrument Calibration.....
100	Calibration Interval.....
Example.....	51
101	Calibration Services.....
Floatresponse tag.....	51
100	Procedure.....
Group tags.....	51
100	Keypad.....
Model tag.....	POWER key.....
99	10
Pause tag.....	LED indicators.....
100	9
Query tag.....	Relay.....
100	deadband.....
Response tag.....	64, 69, 70
100	specifications.....
XML.....	19
2, 99	Remote Commands.....
Data Logging.....	Data Logging.....
31	72
Clearing.....	Returning Equipment.....
72	5
Count.....	RS-232.....
72	configuration.....
Format.....	56
72	connection.....
Interval.....	116
72	specifications.....
Reading.....	19
72	S700.....
State.....	Color Codes.....
72	96
Display.....	mounting.....
resolution.....	96
27	SCPI.....
TC.....	ESE.....
26	62, 65
time constant.....	ESR.....
26	61, 62, 65
Enclosure.....	Instrument Status Enable.....
20	61
cutout.....	Instrument Status Register.....
89	61
dimensions.....	ISE.....
20	61, 62
Environmental.....	ISR.....
20	61, 62
Instrument Stand.....	OPC command.....
90	65
Panel Mount.....	RST command.....
89	65
Safety Concerns.....	Standard Event Register.....
20	61
Safety Symbols.....	Standard Event Status Enable.....
20	65
Ethernet.....	STB.....
10/100-BaseT.....	61, 62
115	*IDN?.....
configuration.....	65
28	sensor.....
connection.....	Connection.....
115	18, 37
Factory Defaults.....	fault.....
54, 55	9
gateway.....	selection.....
55	26
HTTP.....	type.....
54	26
IP.....	units.....
28, 54, 55	9, 25, 26
LabView™.....	Sensor Calibration Curve.....
54	70
patch cable.....	CRV file.....
54, 115	32, 33
SMTP.....	file format.....
54	70
subnet mask.....	
55	
TCP/IP.....	
2, 54, 55	
TIMEP.....	
54	
UDP.....	
2, 54	

Model 9308, 9304 and 9302 Temperature Monitors
INDEX

LogOhms.....	81	Ruthenium-Oxide.....	6, 11, 33, 77, 80, 104, 107, 108
Supported Sensors.....	11	S900.....	6, 33, 103
Technical Assistance.....	5	self-heating.....	17
Temperature Units Selection.....	26	SI-410.....	77
Temperature Sensors.....		Silicon Diode.....	6, 11, 16, 37, 51, 52, 103, 112
Carbon Glass.....	11	Thermal EMF.....	113
Cernox™.....	11, 17, 33, 79, 80, 106, 107	Thermistors.....	17
connection.....	112	thermocouple.....	11, 18, 34, 35, 69, 77, 79, 109, 114
constant-voltage.....	17	Wiring.....	113
CP-100.....	6	XP-100.....	6
DT-470.....	77	XP-1K.....	6
DT-670.....	77	Time constant filter.....	
GaAlAs diode.....	6, 11	Re-seeding.....	10
Gallium-Arsenide.....	18	time-constant filter.....	10, 66, 67
Germanium.....	11, 17	Unit Name.....	66
GP-100.....	6	USB Option.....	
NTC resistor.....	17	configuration.....	56
Platinum.....	16	Utility Software.....	
Platinum RTD.....	4, 6, 11, 15	340 format.....	39
PT10K.....	77	CalGen.....	48
PT1K.....	77	calibration curve.....	44
R400.....	6, 77	CRV.....	42
R500.....	6	CRV format.....	39
Rhodium-Iron.....	11, 16, 77	Curve 340.....	42
RO-600.....	77	Data Logging.....	45, 46
RTD.....	77	Strip Chart.....	45
Ruthenium Oxide.....	17		