

TELEMARK

Operation, Installation and Service Manual

Water Vapor Cryotrap

Models TVP2000 and TVP3500



Telemark Cryotrap TVP2000/3500

Table of contents

Read this first - Health and Safety advice

Introduction

Section 1 Systems Operation

- 1.1. Local (manual mode using the front control panel)
- 1.2. Remote mode operation of a TVP using the 37 pin isolated interface
- 1.3. Full computer mode remote operation using RS232 or other communication standard
- 1.4. Operators quick reference guide

Section 2 Installation Guide

- 2.0 Unpacking, inspection and installation requirements
- 2.1 Preparation of cryo-coil and refrigerant lines
- 2.2 Configuration of remote interface
- 2.3 Full computer mode remote operation using RS232 or other communication standard
- 2.4 Calibration routine "cal2309"
- 2.5 Preparation for operation
- 2.6 Decommissioning

Section 3 Trouble Shooting guide

- 3.0 TVP 4 essential sub systems
- 3.1 Initialisation and start up
- 3.2 Problems during cool
- 3.3 Problems during defrost
- 3.4 Interface and remote control

Section 4 Tables and data

- 4.10 Description of electrical supplies, and controls electrical and system schematics
- 4.11 System with side panel removed showing main sub-systems
- 4.20 Interfacing to the TVP
- 4.30 Principles of operation
- 4.40 Description of safety systems
- 4.50 Cooling curve TVP models
- 4.60 The design and placement of cryo-coils
- 4.70 Recommended spare parts list
- 4.80 Materials safety data sheet
- 4.90 CE Certification
- 4.95 Chinese Hazardous Substances Concentration Table

Section 5 Warranty

- 5.0 Limited Warranty for Telemark Water Vapor Pumps

Glossary

WARNINGS

THE PHRASE WARNING IS USED WHERE THERE IS A HIGH PROBABILITY OF PERSONAL INJURY OR DEATH SHOULD THE PROVISIONS HIGHLIGHTED BE IGNORED. IT IS THE DUTY OF BOTH THE INSTALLER/OWNER AND OPERATOR OF THE EQUIPMENT TO BE FAMILIAR AND COMPETENT WITH THE OPERATION AND USES OF THE PRODUCT. HELP MAY BE SOUGHT FROM THE MANUFACTURER.

- (1) The system contains specific hazards, which present a significant danger to personal safety;
 - (a) high voltage electrical components and high-pressure refrigerant gases, which are a significant frostbite hazard.
 - (b) refrigerant gases, which will cause asphyxiation in confined areas.
 - (c) refrigerant gases, which if exposed to high temperatures decompose to form very toxic by-products – never smoke in the vicinity of a TVP or any other similar system including the gas cylinders.
 - (d) water in close proximity to high voltage electricity.
 - (e) hot and cold surfaces which represent a significant burn / frostbite hazard.
- (2) the system contains gases under pressure, which may constitute both a frostbite hazard and a burn hazard. Refrigerant gases are known asphyxiants and are mildly narcotic. Precautions must be taken and work must only be carried out by suitably qualified personnel.
- (3) removal of any panels other than the front door will expose the operator to high voltage components, which may result in a fatal electrocution
- (4) failure to leak test the system as a whole may result in the catastrophic release of refrigerant, which presents a very high risk from frostbite and or asphyxiation. See emergency shut down procedures and the material safety data sheet for guidance.
- (5) during installation there is the potential to be exposed to high voltage components (up to 400v ac), which may result in a fatal electrocution.
- (6) TVP units must always be operated with a suitable ground/earth line. Failure to comply may result in fatal electrocution. Never tamper with or remove any ground/earth connection from inside of the machine.
- (7) isolate system before connection. Ensure the connection cable used is compliant with local electrical requirements. Cabling within the unit is tri-rated to CSA / UL / CE norms. There should be three power wires and one ground wire; there is no neutral line. Feed cable through gland and terminate at main system isolator, having first removed the protective cover. Ground the TVP at primary ground point.
- (8) failure to replace isolator cover exposes operators to potentially fatal electrocution. It is essential this primary protection always be in place before the system is energised.
- (9) always isolate the system through the main circuit breaker before attaching the remote control. When in remote operation take additional care to prevent personal injury,

(10) the refrigeration system contains a mixed blend of refrigerants and polio-ester oil. These do not present acute health risks it is essential that the following basic precautions are followed:

- (a) always wear eye protection.
- (b) always wear surgical type rubber or latex gloves.

(11) the system contains specific hazards, which present a significant danger to personal safety

- (a) high pressure refrigerant gases, are a significant frostbite hazard.
- (b) refrigerant gases will cause asphyxiation followed by death in confined areas.
- (c) refrigerant gases, which if exposed to high temperatures decompose to form very toxic by-products – never smoke in the vicinity of a TVP or any other similar system including the gas cylinders.

CAUTIONS

The phrase Caution indicates a risk of damage to the product or associated plant and machinery if the provisions are not followed carefully.

- (1) Telemark will not be responsible or liable for either direct or consequential personal injury or loss claims arising from the misuse of the product.
- (2) Unit contains pressurised gas. Do not open hand valves until system is connected to a Cryocoil, which has been checked for leaks. Do not connect the system to other systems unless their design and application has been approved by the manufacturer.
- (3) Closure of the hand valves whilst the system is at cryogenic temperatures may damage the valve seats and invalidate the systems warranty. It must only be attempted on a cryogenically cold system in the case of an emergency, which is causing gross leakage from the Cryocoil or refrigerant lines.
- (4) Do not connect the TVP to an existing Cryocoil without insuring that the Cryocoil will accept the operating pressure of the TVP system and that the whole system has been fully leak checked. Failure to do so could damage the coil and the vacuum system.
- (5) The Cryocoil should be no less than 1/2 inch or 13 mm away from the chamber wall or any other object including other parts of the Cryocoil. Failure to comply will reduce efficiency. It is bad practice to mount the Cryocoil directly onto a metal plate.
- (6) Access to two sides must be maintained: The front/control panel and the right side cooling water/refrigerant line/power/remote control points. No such requirements are necessary for the left side or back of the TVP unit. Although a clearance of 70 mm to allow the door to open fully is required on the left hand side of the unit.
- (7) The correct orientation of the flow is essential if the full potential of the unit is to be realised:
 - Inlet to coil on the right }
 - Outlet from coil on the left }as viewed from right hand side.
- (8) The TVP is phase sensitive, if connected in the wrong orientation the unit will not operate correctly. No damage can be caused by incorrect orientation of the phases.
- (9) Poor water vapour pump performance is often caused by poor insulation or by water collection on the refrigeration lines.

(10) If the lines have visible frosting or water is seen to leak from them during defrost or standby, all of the line insulation must be replaced.

(11) The most common cause of system malfunction are refrigeration leaks. Careful attention to the integrity of the system will ensure optimal performance.

(12) Do NOT repeatedly bend the refrigerant line; this will cause leakage and or breakdown of the insulating materials.

(13) Always attach the refrigerant line to the feed-through coupling.

(14) Leak checking should always be carried out with a helium mass spectrometer leak detector. Any other method may lead to contamination of the system, leaks and ultimately system failure.

(15) Detecting leaks without a helium mass spectrometer is difficult and time consuming for all but the grossest of leaks. The leak rate should be less than 5×10^{-8} mbar/L/S this is outside of the detection range of hand held halogen sniffer.

(16) Most leaks are found at the connections of refrigerant lines, pay particular attention to these areas. It is important that these joints are checked regularly throughout the life of the installation.

(17) Failure to identify and repair leaks before operation will lead to poor performance system contamination and in extreme cases total system failure. In such cases the Warranty will be invalidated.

(18) Ensure the Cryocoil is located in a vacuum chamber and that the chamber is evacuated to at least 0.01 Torr or 1×10^{-2} mbar to prevent overheating of the coil from latent heat.

(19) Before any leaks are repaired the refrigerant mixture must be drawn back into the TVP unit. Using an oil free refrigerant reclaim unit. This requires an experienced technician. Details of how this maybe achieved are outside the scope of this manual.

(20) Do not operate the unit if a refrigerant leak is suspected. Be very careful not to pull a vacuum within the refrigeration lines as this will lead to contamination of the system by water.

(21) Failure to adequately insulate and protect refrigerant feed lines and couplings will result in reduced cryotrap performance, including possible failure of the entire system.

(22) The system uses highly stable PT100 sensors, the temperature measurement system is designed for long-term reliability and stability of temperature measurement. Inferring vacuum performance from the CI/CO values is an unreliable method of process determination. Direct measurement and observation of the vacuum through either an RGA or Penning type gauge are the only reliable methods of evaluating the actual process conditions present.

(23) For process safety reasons the interface has the following command hierarchy:

COOL - Overrides all other actions.

DEFROST - Will revert to STANDBY when complete.

STANDBY - Default state.

(24) To prevent system damage check controlling systems status and the interface is correctly wired before attempting to connect to the TVP.

(25) Do not short circuit the 24 V AC supply (pins 35 & 36) against any pin designated as ground (GND) as this may damage the low voltage circuitry. The system is protected by a manual re-settable 2-Amp thermal fuse located on the left hand side of the remote connector. Ensure that there is sufficient resistance in any external circuit to prevent this value being exceeded.

(26) The remote is fully isolated, there will be a small AC potential difference above the chassis ground/earth. It is important to understand that switching can only be achieved against the ground of the remote interface as opposed to the earth of the unit.

(27) The onboard computer protects the system from misuse therefore it may not always be possible to make the system functional. You may need to wait a short time before engaging a different mode.

TELEMARK TVP SERIES

Classically a TVP is used with an evaporative surface (Meisner/cryo-coil), which is located within the vacuum chamber. When in this configuration a Telemark TVP is an ultrahigh performance vacuum pump capable of pumping water vapor and other condensable gases at speeds far in excess of conventional vacuum pumps.

Your TVP uses the latest advanced heat exchanger and refrigeration technology to give industry leading energy and vacuum performance.

A Telemark TVP couples speed with a sophisticated computer control package which includes a simple and adaptable user interface with isolated interface and RS232 / 485 comms package as standard.

The ranges of tasks to which your TVP can be applied are not limited to pumping water vapor in vacuum. Many are used as substrate coolers (chuck coolers) or other applications where a continuous level of high power cooling in the range -100 to -150°C is required.

Your investment in a Telemark TVP is backed by a 1-year warranty, which is detailed at the end of this manual.

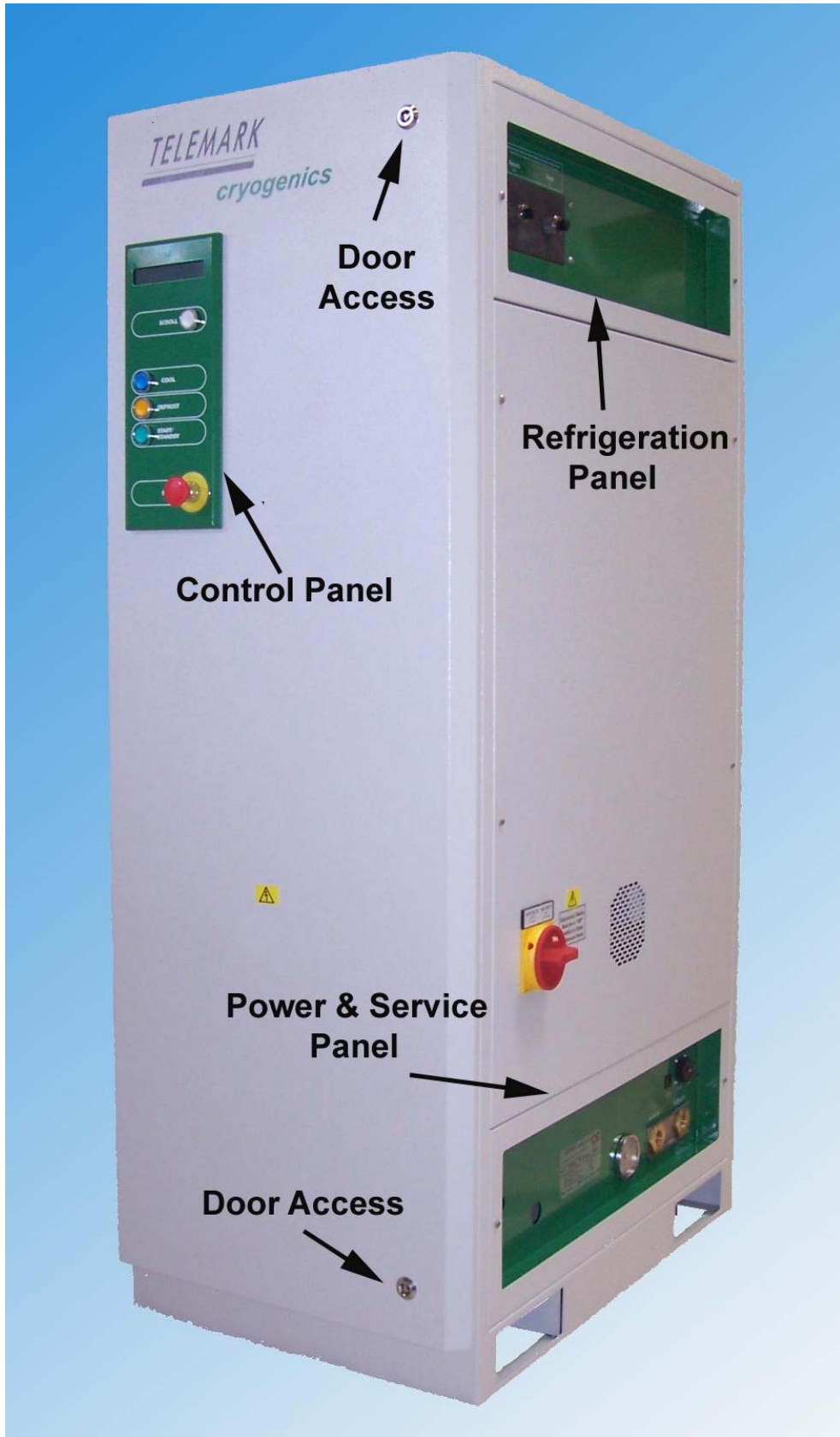

Diagram 1 External view of TVP-

Section 1 System operation

At any time a TVP system and in any control mode maybe safely turned off by depressing the stop / emergency off (EMO) button. (Figure 1)

The following section assumes the system has been installed correctly and covers the following modes of operation.

Warning:

Vacuum systems present many hazards, take time to read this manual and familiarise yourself with your installation

1.1 "Local" (manual) mode using the front control panel-

A TVP water vapor cryotrap is fully protected by a sophisticated computer control system, which allows very simple manual operation. •

The on board computer protects the system from misuse therefore it will not permit operation when system parameters are outside acceptable values. Likewise you may need to wait a short time before engaging a different mode. At any time while the system has power it is possible to use the scroll button, which remains illuminated at all times.

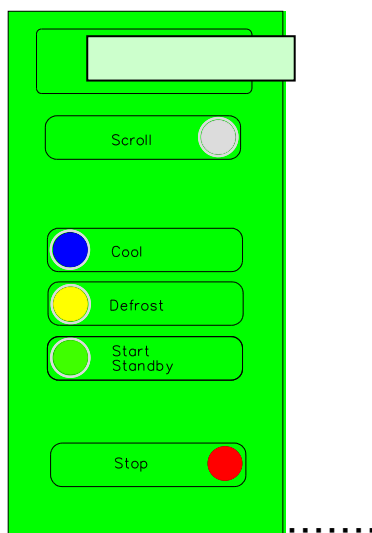

Diagram 2 The display panel

Display character mnemonic	Meaning •	Units
DP	Discharge pressure •	Psi
SP •	Suction pressure •	Psi
CT •	Coldest system temperature (internal measurement)	°C
CI •	Coil in (outlet / flow from unit) temperature	°C
CO	Coil out (inlet / return to unit) temperature	°C
CI2	Second coil value – only dual coil units	°C
E(n)	System error where n = an integer	

Caution

It is good practice to note the balance pressure SP or DP and the coldest temperature CT before starting the system after any extended period of shut down as this can pin point a leak on the refrigeration lines or cryo-coil.

1.101 Resetting the system

To reset the STOP button after actuation it must be turned 90o clockwise, at which point it will click outwards, all other buttons have a momentary actuation. The TVP will automatically reset itself after a forced stop, a manual start or renewed remote start signal are required for restart. If the unit is ready for operation the green start / standby button will illuminate. The illumination of the action buttons is independent of the control mode they also provide status indication.

If the system fails to operate the over pressure trip may have been triggered see diagram 12 in trouble shooting guide on resetting compressor over temperature and pressure protection.

1.102 Switching the system on

Depressing the illuminated start / standby button will start the system – in the case of a dual coil unit only one of the start / standby buttons will illuminate this is normal. The system will start and the display will read "Pre-cool". On a TVP3500 a single compressor starts initially when a CT value of less than -100°c is achieved the second compressor will start.

When the system is in the Pre-cool mode all other modes of operation are disabled, until predefined conditions are met none of the control buttons will illuminate in this state. At the end of the pre-cool phase the Start / Standby button will illuminate to indicate the system is able to start cooling. At all times the scroll button remains illuminated

1.103 Standby

Standby is the normal "resting state" both cool and defrost may be selected when the standby light is illuminated, however defrost will terminate instantly if the CO value is higher than the defrost termination value. In standby the display shows DP and SP.

1.104 Cool

Pressing the blue cool button activates the cool solenoid valve, allowing refrigerant to flow around the cryo-coil. The system display automatically switches from displaying DP and SP to the temperature of the coil inlet and outlet (CI & CO). When the system is in cool the button will remain illuminated.

1.105 Defrost

At any time defrost can be initiated by pressing the orange defrost button. Following the initiation of defrost the cool solenoid valve is closed and the defrost valve is opened an audible click will be heard. When the system is in "defrost mode" the button will remain illuminated.

During defrosting hot gas passes directly from the compressor into the cryo-coil causing very rapid heating. The system monitors the returning gas temperature, and discharge pressure in determining if the cryo-coil has been defrosted. For protection of the system it will terminate defrost and automatically enter standby if greater than 4 minutes have elapsed following the initiation of defrost. If defrost terminates prematurely check the discharge and water temperatures first.

When defrost ends the system automatically enters standby this is indicated both on the display and by the button illumination changing.

1.106 System Recovery after defrost

After defrost it is possible to enter cool immediately however, better results (faster cycle times and lower temperatures) are achieved if a short period (more than 4 minutes) in standby is allowed for the system to recover. The recovery period is in proportion to the defrost termination temperature and the duration of the defrost cycle. A longer defrost period and the higher termination temperature both increase the recovery period. A good rule of thumb is if the discharge pressure is less than 160 psi then it is fully recovered.

Remote display of system status in manual mode can be achieved by using the system condition signals from the remote interface, which remain active at all times. The analog output also reads the coil out condition.

1.2 Remote mode operation of a TVP using the 37 pin isolated interface

All buttons apart from scroll and the emergency off button are disabled by connection of the remote. The system automatically switches to remote operation if a link between pin 9 and 24 is made, this link is already made in the mating connector supplied with the TVP.

The remote is a fully isolated interface and mirrors the operation of the front panel. Making a connection between a system ground pin and the appropriate command pin will change the systems function.

Read back of system function is retained by the buttons on the front panel becoming illuminated. The system also has read back through the remote connector via relays.

For process safety reasons the interface has the following command hierarchy:

COOL – Overrides all other actions.

DEFROST – Will revert to standby when complete.

STANDBY – Default state.

When the remote connector is fully engaged the system will automatically switch from "local" to "remote" operation. This is indicated on the front panel display. When in remote operation all control buttons apart from the STOP / EMERGENCY OFF and SCROLL buttons are disabled.

WARNING

Always isolate the system through the main circuit breaker before attaching the remote control. When in remote operation take additional care to prevent personal injury.

1.3 Full computer mode remote operation using RS232 or other communication standard

TVP units can be controlled or data logged via an integral RS232 port. The port is located on the service panel (diagram 4). Connection to your PC is via your serial port to an RJ11 (US style phone jack). Consult your PC manual or dealer for serial link cable and adapter. A standard adaptor to 9 pin serial port can be obtained directly from Telemark.

Control is achieved using "hyper terminal", which is normally shipped with your Windows PC to control and data log system parameters. •

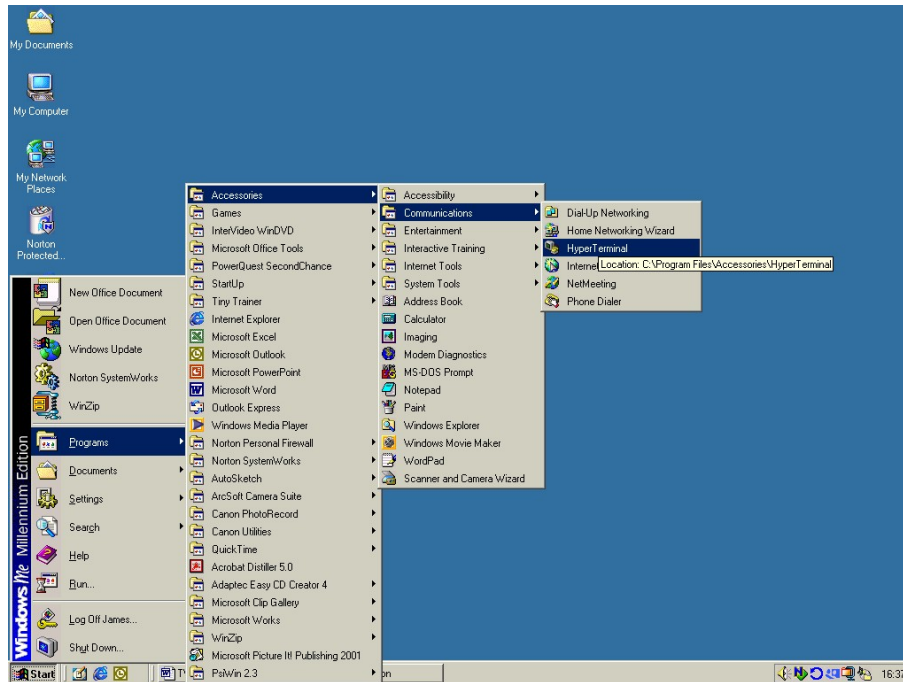

Diagram 3

Having started hyper terminal you are required to enter a connection name. •

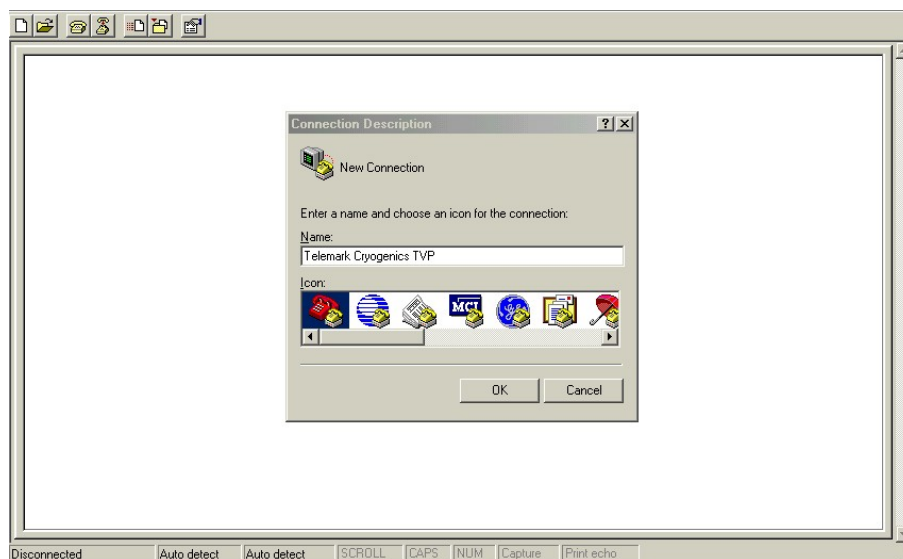

Diagram 4

Hyper Terminal Settings (assumes Windows 95 or newer)
Select the connect using box and set to your serial port (usually COM1)

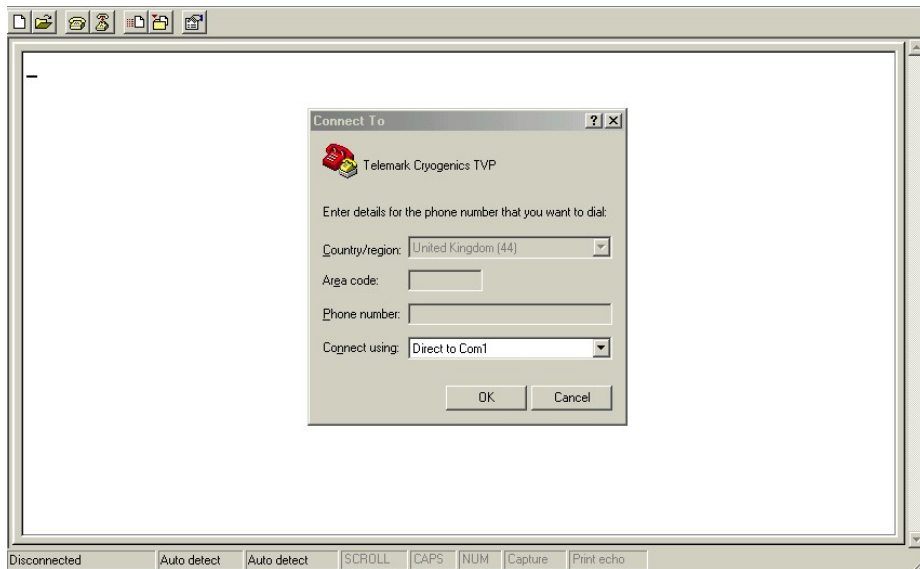

Diagram 5

Select OK.
You will automatically be taken to COM1 properties window.
Select the following settings
Bits per second = 9600
Data bits = 8
Parity = None
Stop Bits = 1
Flow control = Hardware

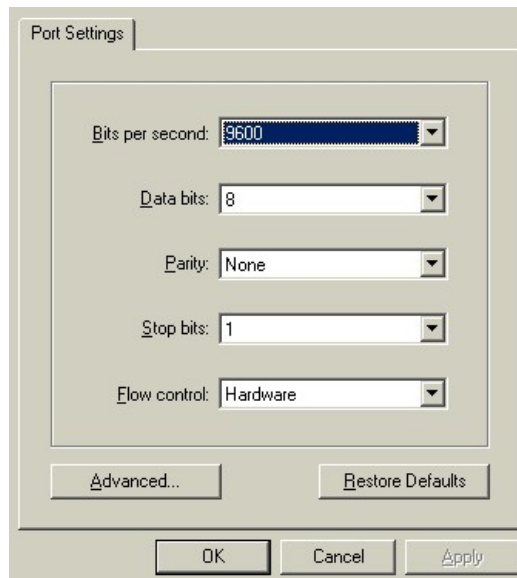

Diagram 6

Enter return and the message following will appear if a connection has successfully been made.

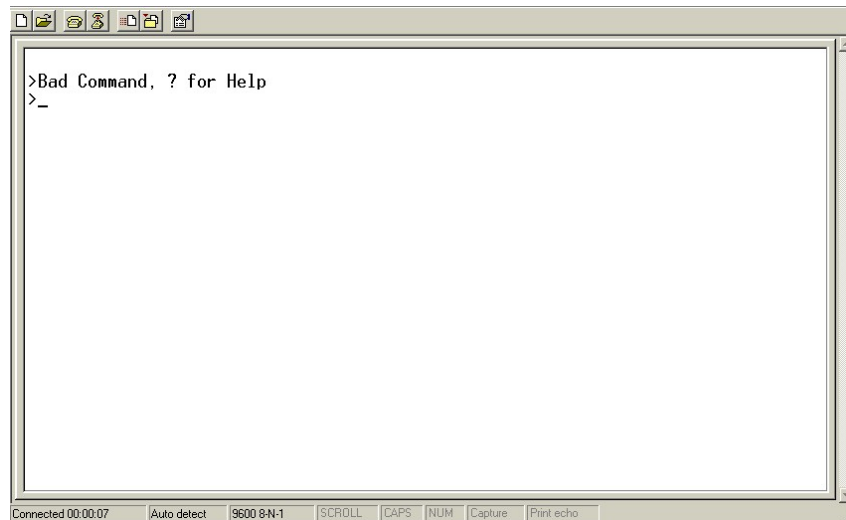

Diagram 7

Entering a query with a "? Return" will give the following screen

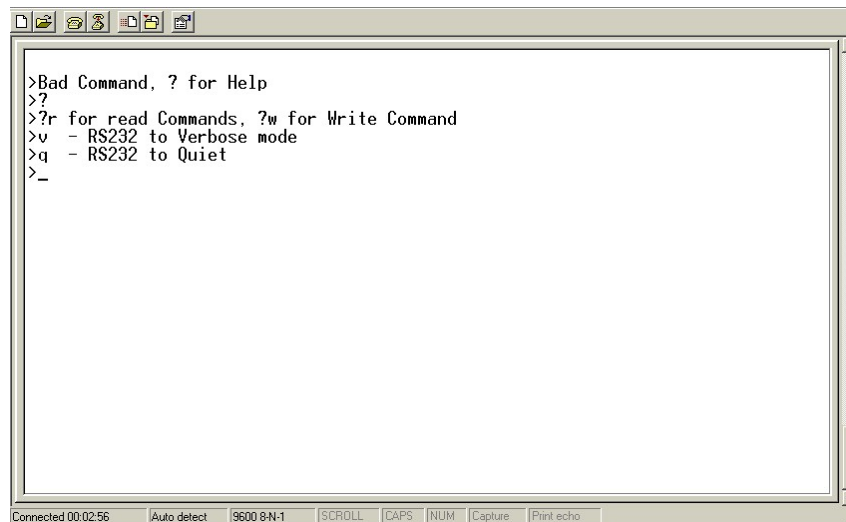

Diagram 8

Note

All commands must be executed as lower case characters followed by return. All commands apart from the specialised calibration routine follow a three-character format.

W2o

Turning the comms link on and allows both data logging (verbose mode) and control of the TVP.

W2f

Turns the link off in this mode so only data logging is permitted

Operational commands

>Read Commands 'r'

Read commands are used to interrogate the systems and are very helpful when diagnosing faults.

```
>   Read Comands 'r'
>-----
> rdp - read Discharge Pressure
> rsp - read Suction Pressure
> rci - read Coil In Temp.
> rco - read Coil Out Temp.
> rwt - read Water Temp.
> rct - read Coldest Temp.
> rc2 - read Coil Out #2 Temp.
> rws - read Water Shutdown Temp.
> rdt - read Defrost Term. Temp.
> rpr - read Set Point Relay
> rsn - read Serial Number
> rsr - read Software Revision
>-----
```

>Write Commands 'w' are used to change status of the system from cool to defrost for example.

```
>-----
>w2o - write 232 control ON
>w2f - write 232 control OFF
>wso - write System ON - switch unit on (standby)
>wsf - write System OFF - switch unit off
>wss - write Standby 1 - Standby main or coil 1
>w2s - write Standby 2 - Standby coil 2 dual coil units only
>wsc - write Cool 1 - Cool or coil 1 dual coil units
>ws2c - write Cool 2 - cool coil 2 dual coil units only
>wsd - write Defrost 1 - defrost coil 1 or defrost
>w2d - write Defrost 2 - defrost coil 2 (dual coil units only)
>-----
```

Please refer to the installation section of the manual for advanced instructions and detailed set up guide.

To operate the TVP under RS232 the following typical control command sequence would be followed:

- I. W2o - Turns RS232 control 'on'
- II. Wso - Turns TVP on
- III. Wsc - System 'cool'
- IV. Wsd - System 'defrost'

(commands III and IV may be repeated indefinitely at each cycle)

Wss - Places systems in standby

Wsf - switches the TVP off

1.4 Operators quick reference guide

Following system parameters ranges are normal any abnormal conditions will be reported via the display and the RS232 link if enabled.

Parameter	Description	Acceptable (normal) range
SP start up *	Suction Pressure	20 to 120 psi
DP start up *	Discharge pressure	100 to 470 psi
SP unit running		7 to 60 psi
DP unit running		100 to 380 psi
SP & DP unit off) ¹	System balance at ambient	235 to 260 psi
CT	Coldest temperature	-100 to -170 °C
WT	Water temperature	35 °C default 40 °C optional
CI	Coil in temperature	+90 °C to -150 °C
CO	Coil out temperature	+40 °C to -150 °C

* Start up only

Balance pressure CT value to be obtained at same time.

Alarm messages

Note all alarm messages before resetting unit. Repeated alarm messages can be an indication of imminent system failure or failure of the water supply.

The system will shut down if control parameters are breached and an error message will be displayed: If a system parameter is breached a manual reset is required. (actuate EMO and resetting)

CAUTION

A forced manual reset means it is the users responsibility to investigate and correct any cause of error before re-starting

Error Code	Display Message	Means
E1	DP High	Discharge pressure high
E2	SP Low	Suction pressure low
E3	WT High	Water temperature high (greater than 35 °C)
E6	DT High	Discharge gas temperature has exceeded 145 °C

For an explanation of the error messages in relation to a possible fault see trouble shooting section (3)

CAUTION

Greater system performance and reliability may be achieved by following a few simple preventative observations

Daily checks

Frost build up on refrigeration lines or feed through. Excessive frost build up can lead to fracturing of metal parts.

System running pressures after a predetermined period of standby ideally at the beginning of the working day.

Weekly checks

System balance pressure SP or DP when CT is above 0 °C i.e. after 48 hours of shut down. Typically Monday morning before system restart.

Water chiller function

Water supply failure is the most common cause of an established system failing

Annual check

System balance pressure SP or DP when CT is above 0 °C

Note-

The system uses highly stable PT100 sensors, the temperature measurement system is designed for long-term reliability and stability of temperature measurement. Inferring vacuum performance from the CI/CO values is an unreliable method of process determination. Direct measurement and observation of the vacuum through either an RGA or Penning type gauge are the only reliable methods of evaluating the actual process conditions present. The actual vacuum relates to the sum of the partial pressures of which water accounts typically 90-98% within a vacuum system. For further information regarding the vapour pumping of water consult Section 4 vacuum data.

Section 2 Installation Guide

Installation

WARNING

The system contains gases under pressure, which may constitute both a frostbite hazard and a burn hazard. Refrigerant gases are known asphyxiants and are mildly narcotic. Precautions must be taken. Work must only be carried out by suitably qualified personnel. Always wear suitable eye and hand protection.

WARNING

All refrigeration work in which the refrigerant gas is moved or manipulated must be done by a qualified technician. Many national laws require individuals who perform such work must have a certification of Refrigeration Technician. Other laws in various countries might govern use or service of this system. Local regulations should be strictly adhered to. Particular attention should be paid to the containment and recovery of refrigerants.

WARNING

The system contains high voltage (either 208 or 415VAC) and high power components. To avoid the possibility of a fatal electrical shock always isolate the unit from the mains supply before working on the system. A qualified technician should carry out the electrical work.

WARNING

Internal parts of the system may either be very hot, or very cold, presenting a possible burn hazard. Always take precautions where the system has been running within the last hour.

WARNING

Read the instruction manual before operation of the TVP Water Vapor Cryotrap.

CAUTION

Do not disconnect, alter or bypass any of the built in safety and protection devices. This will void your warranty and possibly increase the risk of equipment damage.

CAUTION

Unit contains pressurised gas. Do not open hand valves until system is connected to a Cryo-coil, which has been checked for leaks. Do not connect the system to other systems unless their design and application has been approved by the manufacturer, and they have been assessed for leak tightness.

CAUTION

Do not release refrigerant into the atmosphere it is illegal and dangerous; please refer to your local authorities instructions regarding the disposal of reclaimed refrigerants. Read the Material Safety Data Sheet before installing the system. Verify compliance to your local requirements.

CAUTION

Closure of the hand valves whilst the system is at cryogenic temperatures may damage the valve seats and invalidate the systems warranty. It must only be attempted on a cryogenically cold system in the case of an emergency, which is causing gross leakage from the Cryo-coil or refrigerant lines.

2.01 Unpacking and inspection

CAUTION

Before unpacking the unit please verify that the packaging is in good condition, including the tip & tell and shock watch devices. Check these carefully before accepting the unit. If they have been activated contact the shipper and your supplier immediately.

The case is reusable and recyclable. Please treat the environment with respect. When removing the unit from the case ensure that the zip loc bag containing the refrigeration line connections, tool roll and other essential components are not discarded. The TVP is mounted to the pallet with four packing bolts. The wooden pallet on which the unit is shipped must be removed prior to installation.

Inspect the unit for any signs of damage during shipping. If damage is noted contact the carrier immediately. For any further information contact Telemark or your distributor.

System shipping pressure

The TVP was shipped with an approximate standing pressure of 250psi the exact pressure, which the unit shipped with, is noted on the packing list. A pressure gauge is mounted on the green service panel on the lower right hand side of the unit. The static pressure may vary by up to +/- 16 psi with ambient temperature.

Additional items shipped with the TVP

The unit has been shipped with a comprehensive set of tools and components to enable you to install and maintain the unit. Please check all items listed on the packing list are present. Replacement parts list including tools are included in section 4.

2.02 Operating environment

Before installation ensure that the following minimum services are available.

Service	TVP2000	TVP3500
Dimensions (L x W x H) mm	935 x 603 x 1745 mm	935 x 603 x 1745 mm
Floor space required (L x W)	1335 x 803 mm	1335 x 803 mm
Electrical Supply (400 volt compressor code TWD) With recommended protection circuit breaker value	380–420VAC/3-ph/50 Hz(35 Amps) 460 VAC/3-ph /60 Hz (35 Amps)	380– 420 VAC/3-ph/50 Hz (60 Amps) 460 VAC/3-ph /60 Hz (60 Amps)
Electrical Supply (200 volt compressor code TWC) With recommended protection circuit breaker value	200 VAC/3-ph/50 Hz (60 Amps) 208–230 VAC/3-ph/60 Hz(60amps)	200 VAC/3-ph/50 Hz (90 Amps) 208–230 VAC/3-ph/60 HZ (90Amps)
Water flow requirements at 15°C inlet temp (40°C Outlet)	6 L / min	12 L / min
Heat dissipated to water at peak load kW	11	20.4
Shipping weight	384 kg	494 kg
Water connections	¾" NPS female	¾" NPS female
Noise level dba @ 1m	72	74.5
Refrigeration line connections Parker	2 x female Ultraseal supplied	2 x female Ultraseal supplied
Refrigeration line connections VCR (optional)	VCR 8 male & female supplied	VCR 8 male & female supplied
Water quality	Ph 6.5 – 8 0.1 M ohm resisting chloride free	Ph 6.5 – 8 0.1 M ohm resisting chloride free

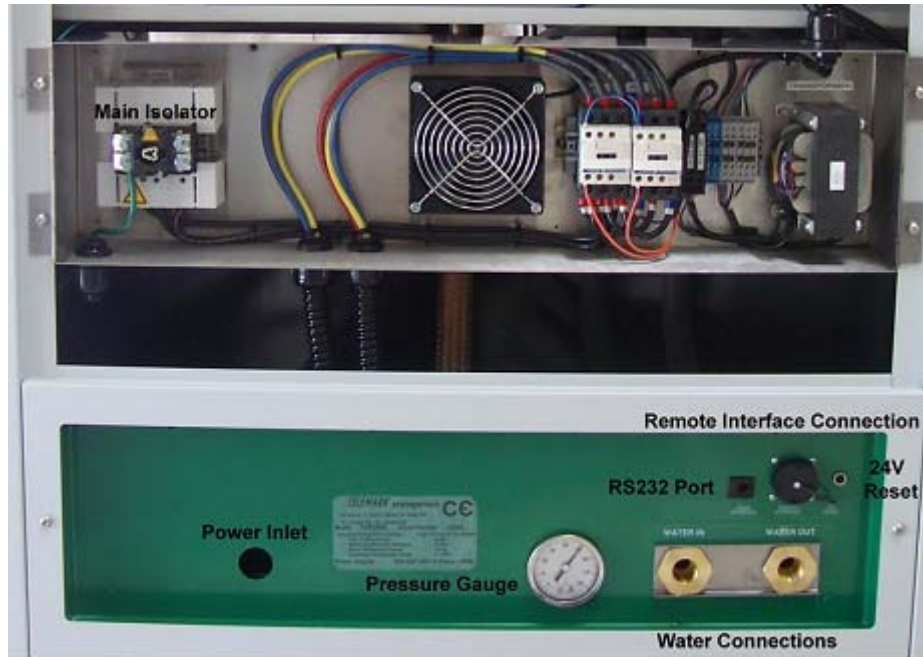

Diagram 9 Services panel

Warranty Card

Included with every system is a warranty card. Please complete this and either post, email or fax the form to the address shown. We will register your machine and ensure that you receive the latest software upgrades. Failure to complete the warranty card may cause delays in servicing or providing parts.

CAUTION

The TVP must only be moved either by forklift or by strapping through the forklift truck points. Do not install the system on shipping pallet.

2.03 Location of TVP

Position the TVP to minimise the length of the refrigeration lines. It is also important that the lines are well supported and are manufactured from annealed copper tubing allowing for thermal expansion and vibration.

CAUTION

70mm access to left hand panel must be maintained to ensure air flow to the unit compressor.

2.04 Electrical Power Installation

The electrical system requires no neutral, a circuit breaker with a value suitable for the maximum current draw must be selected. Local electrical codes must be followed in selecting the correct values. The unit is phase sensitive and may require the phases to be swapped following initial start.

CAUTION

Phase protection against the loss of phase is strongly recommended.

WARNING

The system contains high voltage (208 or 415VAC) and high power components. To avoid the possibility of a fatal electrical shock always isolate the unit from the mains supply before working on the system. A qualified technician should carry out the electrical work.

TRANSFORMER CONNECTION

Main Power selection is made at the factory during manufacturing. The units are constructed as either "low power" (208-230 VAC/3-phase/60Hz or 200 VAC/3-phase/50 Hz) or "high power" (380-420 VAC/3-phase/50 Hz or 460 VAC/3-phase/60 HZ). Completely different compressor models and other internal components are used between the "low power" and "high power" versions and are not intended to be automatically interchangeable. The transformers for the "low" and "high" have differing part numbers and the correct TAP locations are:

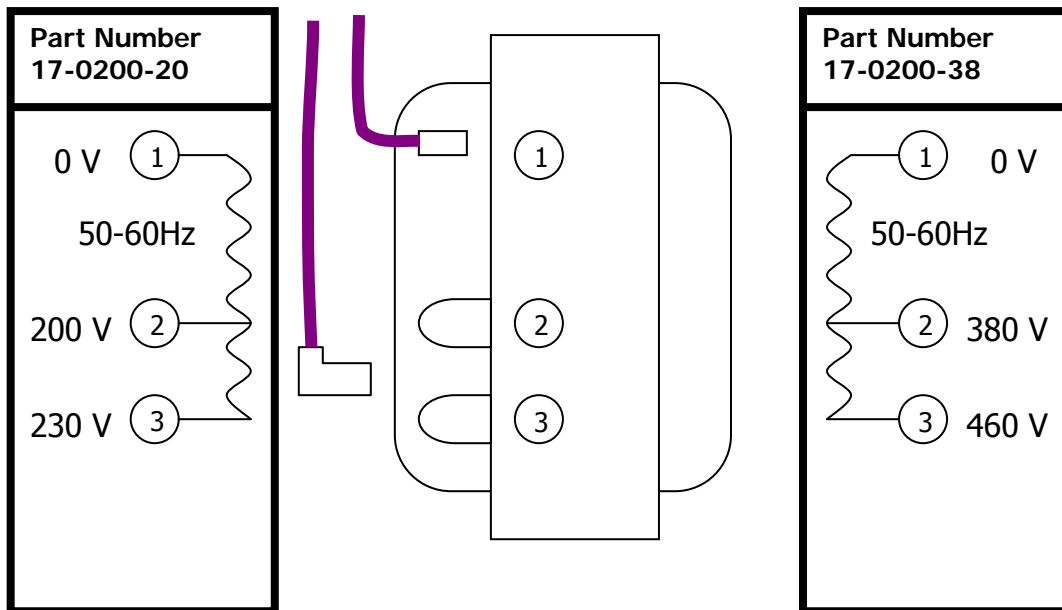

2.05 Cooling Water requirement

The advanced design of a TVP means it is capable of operating over a wider range of water temperatures than traditional systems. Optimal water outlet temperature (WT on the display) is 25 °C, however there is little loss of performance with water outlet temperatures as high as 35°C. Higher water temperatures result in a slight loss of capacity whilst water colder than 15°C will slow the systems response and lead to undue condensation on water lines. The preset maximum water outlet temperature is 35°C this may be adjusted in the range 20°C to 40°C to suit your building services. See section 8

Cooling water may be supplied from local water supplies: this is damaging to the environment. In-house re-circulating water-cooling system is therefore more acceptable. Water must be free from chlorides and sufficiently soft to prevent the build up of lime scale (0.1 MΩ resistivity). Ensure that the water is clean and free from any clogging debris

Turn on water flow and ensure no leakage is present at connectors. Open the cabinet and check visually for water leaks inside the cabinet. Water temperature below ambient, may cause condensation. Additional insulation of the internal water lines may be required if the cooling water is low and the humidity high. The best solution however is to increase the water temperature until the condensation is no longer produced.

The graph below indicates the cooling water flow required for a 35°C outlet temperature at varying inlet temperatures. As a practical limit a flow rate of 30 L/Min is approximately equivalent to a 15psi pressure drop across the TVP.

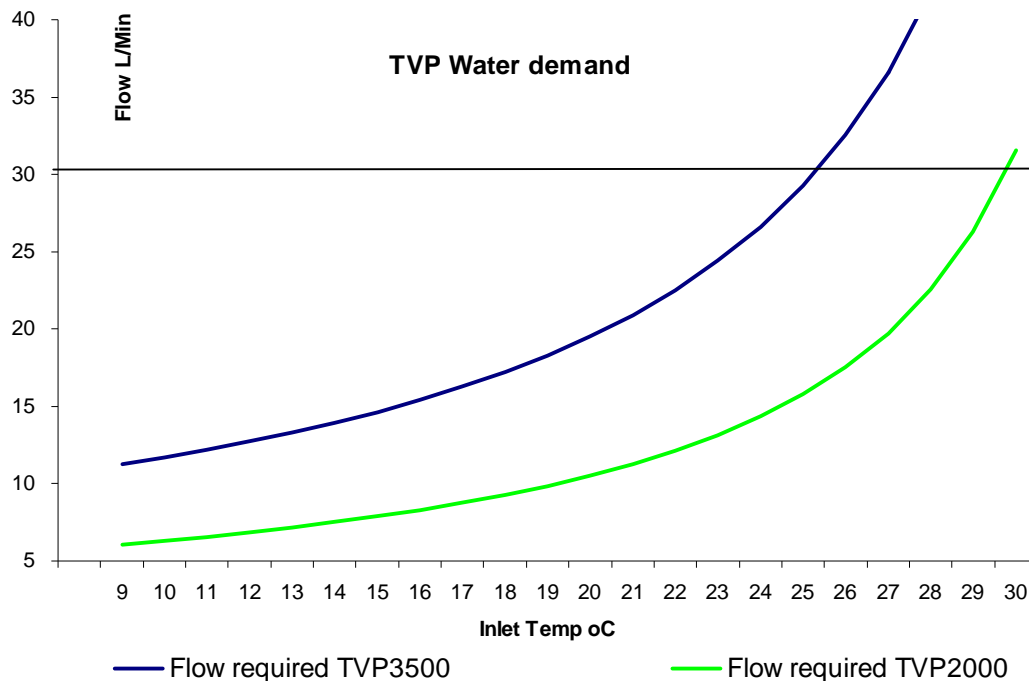

Diagram 10

As a practical limit 30L/min approximates to a 1 bar pressure drop across the TVP. We recommend that opaque flexible reinforced lines are used. Install the hose tail connections onto the water supply line and return (drain) line using PTFE tape on threaded connections and worm drive (jubilee) or similar type clips. The use of a suitable biocide can be beneficial when used in closed loop water systems.

CAUTION

Correct orientation of the water flow is essential • Inlet on the left • • • Outlet on the right

2.06 Installation of the Cryo-coil (Meisner trap)

The design and placement of a cryo-coil is a specialised task, which must be carried out by a skilled vacuum practitioner. Free technical help and design service are available directly from Telemark. Telemark also manufactures cryo-coils to order to suit your installation.

WARNING

Failing to leak test the system as a whole may result in the catastrophic release of refrigerant, which presents a very high risk from frostbite and/or asphyxiation. See emergency shut down procedures and the material safety data sheet for guidance. •

CAUTION

Do not connect the TVP to an existing cryo-coil without ensuring that the cryo-coil will accept the standing pressure of the TVP system (245psi) and that the whole system has been fully leak checked. Failure to do so could damage the coil and the vacuum system.

It is assumed that the cryo-coil and associated vacuum feed-through are in their final operating position and are leak tight to better than 2×10^{-8} mbar/l/s. The only satisfactory way to verify the system is leak tight to the required standard is by using a mass spectrometer. •

It is good practice for cryo-coils with attached feed-through to be installed from inside the chamber so that there are no connections within your vacuum system, verify that moving parts within your vacuum chamber do not interfere with the cryo-coil. Telemark supplies a range of high quality vacuum feedthroughs, which compliment its range of refrigeration lines.

CAUTION

The cryo-coil should be more than 2 diameters away from the chamber wall or any other object including other parts of the cryo-coil. It is bad practice to mount the cryo-coil directly onto a metal plate. The ideal cryo-coil should have a large surface area but also be of low mass. The cryo-coil should be capable of accepting a working pressure of 245 psig. If chamber radiant heating is being used aluminium foil placed between the cryo-coil and the heat source is a very effective heat shield. Radiated heat from any source in a vacuum chamber will have a detrimental effect on your systems performance.

WARNING

Fully familiarise yourself with the main functional elements of the system before installing.

CAUTION

Refer to site guide and ensure all facilities are available before installing your TVP.

2.07 Installation of refrigeration lines

Refrigeration lines can be made but should conform to the following norms. •

Coil inlet line diameter	9.5mm – 3/8" to 15mm – 5/8"
Maximum recommended length	5m (15ft)
Coil outlet line diameter	15mm – 5/8" to 19mm – 3/4 "
Maximum recommended length	5m (15ft)
Minimum insulation	60mm of closed cell "Armaflex" type

CAUTION

To maximise system performance the refrigeration lines should be as short as possible. •

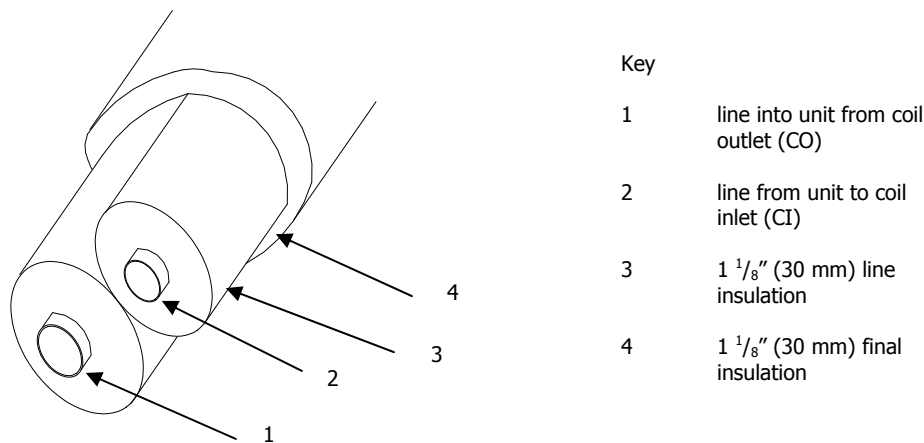

Diagram 11 Insulation of refrigerant lines

Telemark manufactures conventionally insulated refrigeration lines to order to suit your installation.

When installing the refrigerant lines it is essential to protect the lines and fittings from the entrance of moisture, such as water vapour, which causes rapid degradation of any foam type insulation. An effective vapour barrier is best achieved by using the approved rubber based impact adhesive followed by sealing of all glued edges with duct tape or 13mm electricians type PVC tape.

CAUTION

If the lines have visible frosting or condensation is seen to leak from them during defrost or standby, all of the line insulation must be replaced. •

TVP refrigeration line connections are recessed to protect against accidental damage. When replacing a traditional cryotrap an adapter may be required, the best solution however is to remove the old connections from the lines replacing them with the stubs supplied in the TVP tool kit. All copper-to-copper joints must be silver or hard soldered, soft solder is unacceptable. •

2.08 Refrigeration line fitting instructions for Parker connection

Inspect and clean all coupling faces. Ensure they are free from dents or scratches. Small imperfections on the Parker fittings of the refrigerant lines may be rectified by using 1200 grade wet or dry mounted onto a glass plate. Special care needs to be taken when handling Swagelok VCR fittings. It is critical that the faces are totally flat and square. Always purge lines through with dry nitrogen to prevent contamination of lines. When using the 1200 grade wet or dry ensure the abrasive pad is always dry.

It is recommended that the connections on the cryo-coil are Parker Male couplings (i.e. Those with the 'O' Ring groove) as these are more delicate than the female, flat face seal, half of the coupling.....

Position the refrigerant lines to suit the installation. Bend the refrigerant line as necessary. The minimum bend radius is 12 inches (300mm). Ensure at least 5 inches (150mm) of straight line runs to the TVO unit and to the feed-through coupling..

CAUTION

- 1) Do NOT repeatedly bend the refrigerant line; this will cause leakage and or breakdown of the insulating materials
- 2) Always attach the refrigerant line to the feed-through coupling.
- 3) Always use the o-ring removal tool, which is supplied in your tool kit when removing an "O-Ring".

It is vital that a new o-ring is used every time a connection is made or broken. Always use the o-ring removal tool, which is supplied in your tool kit when removing an "O-Ring". Take care not to damage mating surfaces of the connections.



Diagram 12 Parker O ring removal tool

It is our recommendation that Parker fittings are fully tightened

Swagelok (VCR) fitting instructions

CAUTION·

VCR fittings are very susceptible to damage to the sealing surfaces therefore extreme caution must be taken not to damage the sealing surfaces.

Always use the correct washers supplied in your tool kit. It is not possible to redress the surfaces as described for Parker fittings.

Verify the isolation valves inside access door on front of TVP unit (under the panel) are closed (see diagrams 14a and 14b).

Remove the blank-off fittings from the coupling lines on the unit. Some refrigerant gas may escape. If this continues the valves are not properly closed or have failed. If valves have failed replace the blank-off fittings immediately and contact your vendor.·

Attach the refrigerant line to the TVP unit in the same manner as described above. Over tightening Cajon VCR fittings will cause distortion of the washer and leaks.

Provide support for the refrigerant line. This should occur at mid point on a 2 m line. Ensure that the support is in contact with the insulation only and not in contact with any exposed tubing or couplings.



Diagram 14a

TVP 2000/3500 single coil unit
valve arrangement

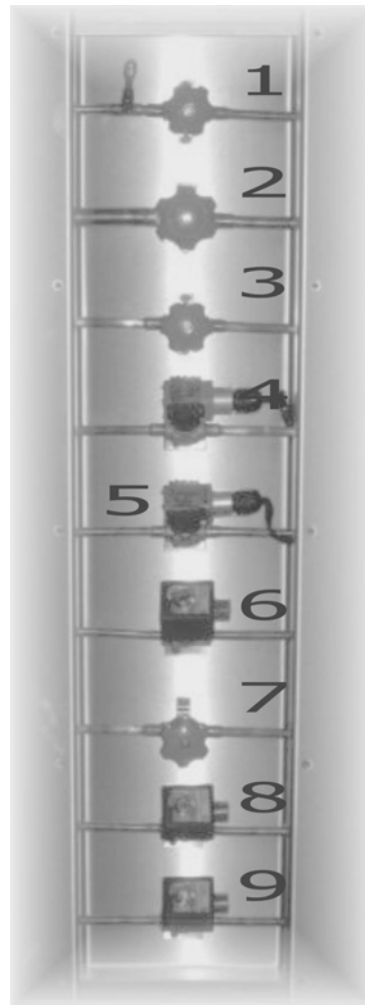

Diagram 14b

TVP 2000/3500 dual coil unit valve
arrangement

Valve box

1. Access hand valve
2. Suction (common return valve)
3. Common defrost hand valve
4. Defrost solenoid valve coil 1.
5. Defrost solenoid valve coil 2.
6. Start valve
7. Common cool hand valve
8. Cool solenoid valve coil 1
9. Cool solenoid valve coil 2.

2.09 Leak checking the cryo-coil and refrigerant lines

CAUTION·

Connection of the refrigerant line and final preparation of the system must be carried out by a fully qualified and experienced refrigeration engineer.·

CAUTION·

Leak checking should always be carried out with a helium mass spectrometer leak detector. Any other method may lead to contamination of the system, leaks and system failure.

Connect a refrigeration manifold gauges suction hose (low pressure) to the TVP access hand valve. Open the valve control stem to mid-point. Connect the helium cylinder to the manifold gauge centre port. Pressurise the refrigerant line and cryo-coil to 150 psig (10 bar). The system may be back filled with nitrogen. (Helium at least 3 bar minimum is required before backfilling with a minimum of 10 bar dry Nitrogen)

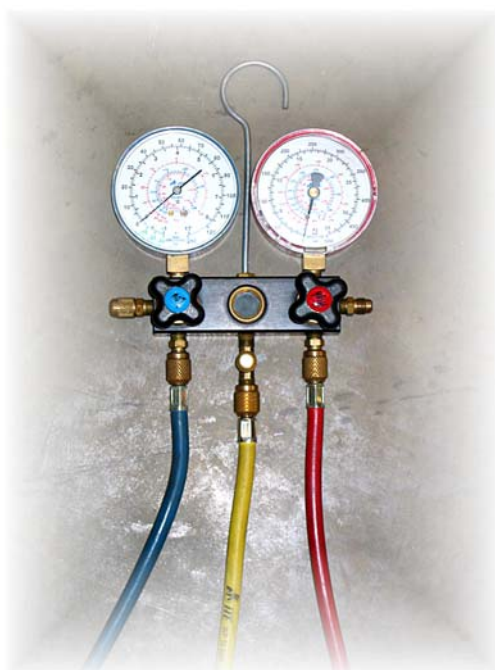

Diagram Refrigeration manifold

Detecting leaks without a helium mass spectrometer can be time consuming. The target leak rate should be less than 5×10^{-8} mbar/L/S this is outside of the detection range of hand held halogen detectors.·

It is however possible to locate gross leaks using a standard refrigeration leak detector and refrigerant. Interference from the glue and the foam insulation of the refrigerant lines makes effective leak detection difficult. It is illegal in many countries to use refrigerants as trace gases for leak detection. Following the procedure above replacing helium for refrigerant works well with thermal conductivity type leak detectors.

Using a refrigerant leak detector to identify leaks.

Check each connection that has been made at both TVP and feed-through end with a halogen leak detector, check each coupling carefully. Couplings have two holes, which help identify the specific location. Covering one of the holes and detecting at the other side is an effective method of checking a coupling (both Parker and VCR types)

CAUTION•

Most leaks are found at the connections of refrigerant lines, pay particular attention to these areas. These joints should be checked regularly throughout the life of the installation. Check all brazed joints for any leaks. Check valve bodies in the valve box.

If a leak is found at a Parker coupling, ensure that the joint is fully tightened. If the leak persists the joint will have to be disassembled and re-seated. Parker fittings may be re-surfaces using 1200 grade wet or dry paper mounted on a glass or "Tufnol" block. •

Leaks on a brazed joint must be repaired using hard solder. Open the manifold valve and release the gas from the refrigerant line and cryo-coil before attempting a repair. •

CAUTION••

Failure to identify and repair leaks before operation will lead to poor performance system contamination and in extreme cases total system failure.

2.10 Preparation of cryo-coil and refrigerant lines

It is essential a two-stage vacuum pump capable of better than 3×10^{-3} mbar is used. Standard refrigeration manifold lines and an oil free reclaim unit are essential. Always start from the position of having all of the valves on the manifold and the TVP closed when carrying out any service or installation work. •

Evacuate the refrigerant lines and cryo-coil through the system access valve to 0.005 mbar or less. As evacuation refrigeration lines are severely conductance limited a minimum evacuation time of at least two hours is recommended. Close the TVP unit's access valve while the vacuum pump is still running. Close all hand valves and isolate the system before turning the vacuum pump off. •

If the system pressure is greater than 235psi back filling of the line will probably not be required unless they are very long. The common return cool and defrost hand valves maybe opened ideally in that order. •

Your objective is to achieve a static system pressure at ambient with the hand valves open of 235 to 250psig. Above this value the system may trip it's over pressure trip and below this range full cooling capacity may not be realised. If the system pressure is outside this range use a top-up charge to increase system pressure or reclaim unit to reduce the pressure. •

2.11 Connection of external temperature sensors

To optimise the cycle time for any given system it is good practice to use the remote sensors and place them on the refrigeration lines as close as possible to the vacuum feed-through as possible.

A TVP uses PT100 platinum resistance sensors, which offer greater stability, accuracy and durability than thermocouples. External sensors with 6m leads are included in the package; they maybe extended to 12m with low impedance wire, with no loss of accuracy. •

To connect the remote sensors remove the blanking connector and insert the remote sensors supplied. The system will automatically switch to the external sensor. See diagram 9 for location and connector



Diagram 15 Remote sensor attached to copper line.

Telemark has supplied high quality sensors with a ductile stainless steel sheaths never directly silver solder these couplings onto refrigeration lines. Solder a 1/4" copper line on to the refrigeration where they leave the vacuum feed-through and insert the sensor into the pocket formed use a little thermally conductive grease. •

2.12 Connecting the remote interface

TVP units are supplied with a fully isolated remote interface suggested wiring schemes are proposed in section 4. Using the connector supplied will automatically force the TVP into remote mode. Removal of the connector the unit will switch to "Local" (manual) mode

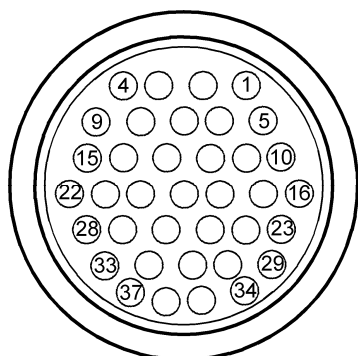

Diagram 16. The remote interface connector showing pin numbering (connector end)

A TVP only requires a simple contact closure to effect a change in state, likewise any change in state is indicated by a relay closure at the TVP. Where the vacuum system provides voltage signals these must be isolated from the TVP by a relay. A range of adapters for common interface patterns are available directly from Telemark •

CAUTION•

Always isolate the TVP from the power supply when carrying out service work with the remote connected.

The TVP provides a 2 AMP 24VAC supply to power relays and to provide signalling to your vacuum systems – See section 4 for suggested wiring schemes. •

CAUTION•

The TVP cannot accept external voltage inputs of any kind as they can lead to spurious system measurements. •

CAUTION•

Do not short circuit the 24 V AC supply (pins 35 & 36) against any pin designated as ground (GND) as this may damage the low voltage circuitry. ••

The system is protected by a manual re-settable 2-Amp thermal fuse located on the right hand side of the remote connector. Ensure that there is sufficient resistance ($>32\Omega$) in the external circuit to prevent this value being exceeded. •

NOTE

Ground is not earth on the TVP.

A mating male half and pins are supplied. The correct insertion/extraction tool (supplied) must be used when making up the remote interface connection. If there is no voltage signal back from the unit, try re-setting the fuse first.

The TVP remote has the following hierarchy for relay closures.

Cool

Defrost

Start / Standby (systems operate)

In practice this means only two relay closures are required for effective operation, system operate and cool. If defrost is permanently linked within the interface connector the systems automatic termination of defrost can be exploited.

2.20 Configuration of the remote interface

The User Interface is automatically enabled when pin 9 is connected to system GND (pin 24); this link is installed in the supplied connector. •

When the connector is inserted, the system switches to REMOTE - indicated on the top, left of the LCD display. In REMOTE only the "SCROLL" key functions, but all the indicators continue to function (i.e. COOL, DEFROST, STANDBY) along with the RS232 read commands (includes logging). •

The system can only be taken out of remote by either removing the connector or by selecting RS232 control via the serial link.

All the remote indicators function at all times regardless of system status. i.e. The system can be in LOCAL or RS232.

2.21 Digital Inputs

The digital inputs accept an input voltage with a digital threshold at ~2.5 volts. The inputs are protected against overload over a range from -48 to +48 volts. These inputs are useful for detecting contact closures or sensing devices with open collector transistor outputs, logic level outputs can also be detected as long as they are from a CMOS logic output guaranteed to swing at least 3.5 volts.

The input has an RC circuit with a 0.2-millisecond time constant to stabilise signals, signals faster than 5khz can be effected.

2.22 Digital Outputs•

The digital outputs are fully isolated, they provide a contact closure to ground rated for up to 1A @ 24 VAC. The commons are all linked for the user to connect to ground or apply a voltage (pins 4, 6, 17, 29) a 24 VAC source fused at 2A is provided on pins 35 & 36 to drive external relays.

2.23 Suggested Wiring Schemes (see drawing)

Basic Interface• - single coil units

Note Pin low indicates connection between operate and system ground has been made.

Connect pin 9 (remote enable), pin 1 (operate unit), pin 13 (operate defrost) to pin 2 (GND). •

On power up the unit will be forced into remote by pin 9 being low, it will then see pin 1 low and turn on the compressor and start the PRE-COOL cycle. When pre-cool ends the system enters STANDBY and seeing pin 13 low, forces a defrost cycle this will terminate when CO reaches the Set point – the defrost cycle may only be momentary as the CO value maybe higher than the set point.

On completion of defrost unit will enter STANDBY and is now ready to be controlled.

To COOL the coil a closure between 11 and system ground needs to be made. In dual, while pin 11 is low, the system will remain in COOL.

Defrosting is achieved by breaking the link between 11 and ground allowing the system to see pin 13 low it will then complete a DEFROST cycle before returning to STANDBY.

In this basic scheme the system will always do a complete cycle, i.e. It will perform COOL – DEFROST – STANDBY. •

This can be expanded by adding a second switch between pin 13 and GND to select Defrost, here if both switches are open the system is in STANDBY, to select COOL close pin 11 to GND. To select defrost close pin 13 and then open pin 11.

Dual coil systems

Caution

The system updates the I/O @ 70 milliseconds, if cool is removed before defrost is applied the system will go into STANDBY momentarily. This can cause a problem for some slow to update systems.

.....

1) Full interface

This shows the complete I/O for the two coil TVP.

The control inputs are exactly the same as above but with two additional inputs for COOL 2 and DEFROST 2.

The digital outputs are shown with either a customer supplied power supply, the internal 24 VAC (fused 2A) or the outputs can be connected to system Ground for customer systems with open collector inputs.

2.30 Full computer mode remote operation using RS232 or other communication standard

TVP units are capable of being controlled and data logged via an integral RS232 port, this is accessible on the services panel diagram. Connection to your PC is made via your serial port to an RJ11 (US style phone jack). Consult your PC manual or dealer for serial link cable and adapter. An adapter cable is available from Telemark.

Connection to your PC is achieved using hyper terminal, which is normally shipped with your Windows to control and data log system parameters. •

Hyper Terminal Settings (assumes Windows 95 or newer) hyper terminal is normally found under programs/startup/accessories/communications folder of windows.

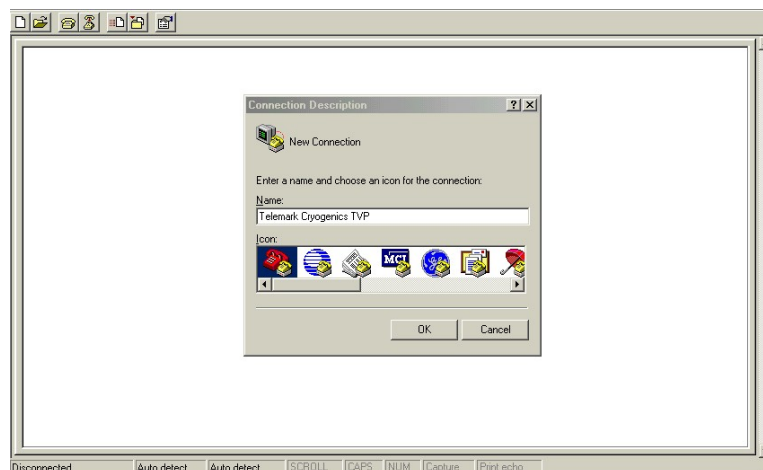
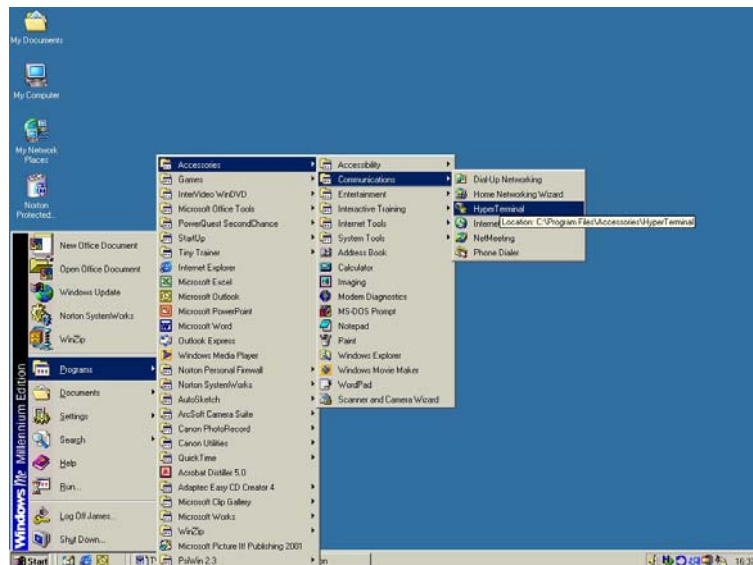

Select the connect using box and set to your serial port usually COM1

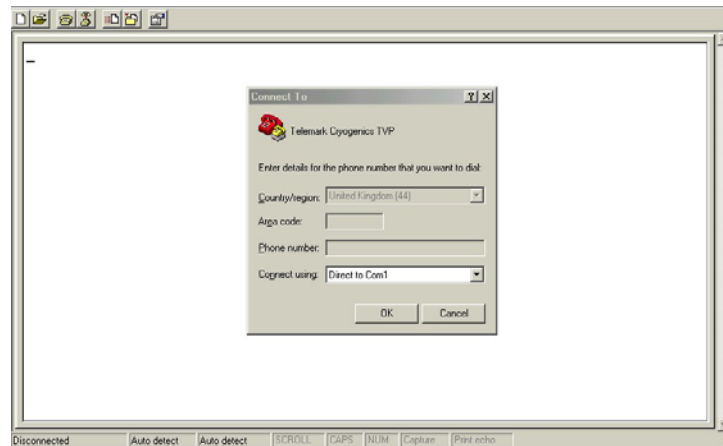

Select OK.

You will automatically be taken to COM1 properties window.

Select the following settings

Bits per second = 9600

Data bits = 8

Parity = None

Stop bits = 1

Flow control = Hardware

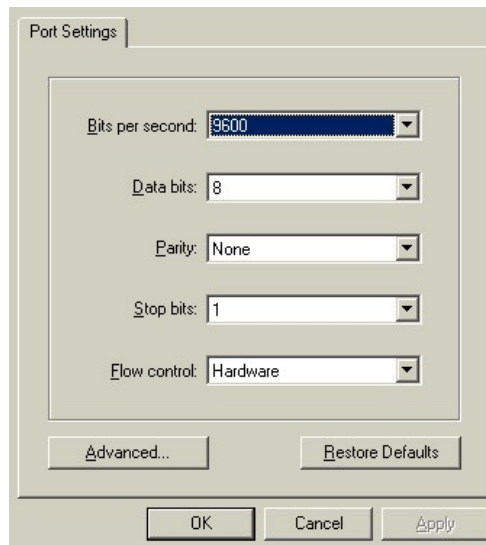

Enter return and the message will appear if a connection has successfully been made.

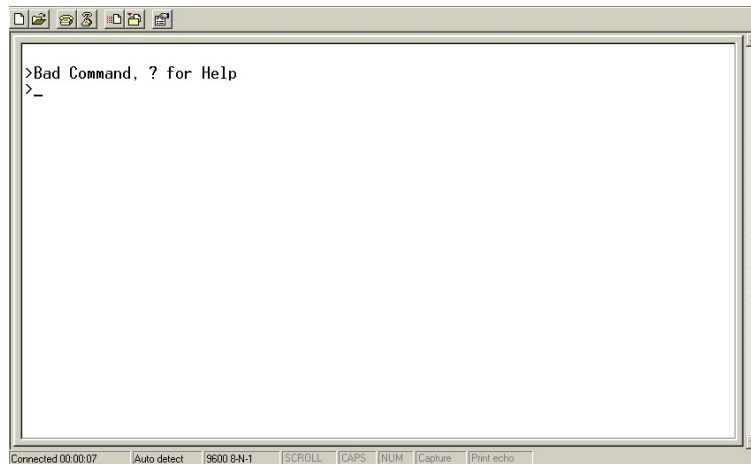

- >?R for read Commands, ?W for Write Command
- >v – RS232 to Verbose mode
- >q – RS232 to Quiet

Entering a query with a “? Return” will give the following screen

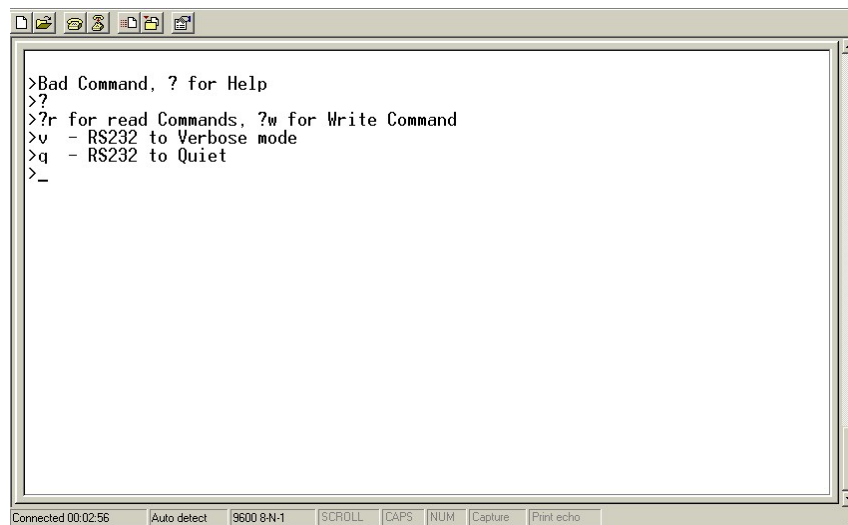

2.31 Commands available when using RS232 control

NOTE

All commands must be executed as lower case characters followed by return. All commands apart from the specialised calibration routine follow a three-character format.

W2o

Turns the comms link on

W2f

Turns the link off

Operational commands·

```
> Read Comands 'r'
>-----
> rdp - read Discharge Pressure
> rsp - read Suction Pressure
> rci - read Coil In Temp.
> rco - read Coil Out Temp.
> rwt - read Water Temp.
> rct - read Coldest Temp.
> rc2 - read Coil Out #2 Temp.
> rws - read Water Shutdown Temp.
> rdt - read Defrost Term. Temp.
> rpr - read Set Point Relay
> rsn - read Serial Number
> rsr - read Software Revision
>-----
```

>Write Commands 'w'

```
>-----
>w2o - write 232 control ON
>w2f - write 232 control OFF
>wso - write System ON
>wsf - write System OFF
>wss - write Standby 1
>w2s - write Standby 2
>wsc - write Cool 1
>ws2c - write Cool 2
>wsd - write Defrost 1
>w2d - write Defrost 2
```

2.40 Calibration routine "cal2309"

During installation it is possible through a computer running hyper terminal to adjust a number of system parameters to match your application requirements.

Type return at the prompt "Bad Command, ? For Help" in the hyper terminal window type "cal2309 return"

The following will be displayed:

```
Cal2309
>      Parameter Setup
>Compressor Cycling(1) Non-Cycling(0)  1 SLOW =   5 psi
>Single=0 or Dual=1 (Coil). = 1
>Set Point Relay= 1
>Option 1: Comp. Running. DEFAULT (cr)
>Option 2: Coil Out Temp.      (co)
>Option 3: Discharge Pressure. (dp)
>Defrost Term. temp. (dt)=   0 C
>Defrost Term. SP.    (ds)=  100 psi
>Water Shutdown Temp. (ws)=   40 C
>Logging Interval.   (li)=   1 sec
>Select parameter to change or 'def' for defaults
```

From this point it is possible to change the following items

Defrost termination temperature (always the coil out CO value)

Data logging interval

Choose the parameter and the value for the set point relay

After entering any command change followed by enter you automatically leave the ">Calibrate Active" mode. To change an additional parameter type ""cal2309 return""

2.41 Changing Defrost termination temperature

Type "dt" return

You will be asked to input a value type value followed by enter – note a lower temperature can dramatically shorten the overall cycle time.

2.42 Changing Water shut down temperature

Type "wt" return

You will be asked to input a value type value followed by enter – Note the default is 35°C

2.43 Changing the set point relay

There are three possible parameters against which the system ready signal can be produced; Coil out (co) useful if a particular partial pressure of water needs to be reached before processing starts.

Coldest temperature (ct) useful if the system has a very long defrosting time as it indicates the systems readiness to start cooling.

Compressor running (cr) the default value commonly used in coating plant manufactured by Leybold and other German manufacturers.

NOTE – When in the ">Calibrate Active" if the co or ct modes are selected you will then be prompted to input the temperature of the set point.

2.44 Changing the logging interval (li)·

Type li return when in the ">Calibrate Active" mode and you will be prompted to enter a logging interval between 1 and 1000 seconds. Logging only occurs when the unit is in verbose mode.

2.45 Data logging·

The data logging function works even when the RS232 link is not activated, however the RS232 link must be opened to activate the logging mode.

Type "v enter" the unit is now in verbose mode and data logging. The rate at which logging occurs is defined by the Logging Interval function li under "cal2309".·

The data appears in columns in the following order.

Discharge pressure, Suction Pressure, Coil in, Coil out, Water Temp, Coldest Temp

The data logged file is comma and space delimited and may be saved as such and then imported into excel or other data processing package.

Hyper terminal can only carry 500 lines of text when data logging a system where more than 500 readings will be made the file can be written to a text file using the data capture feature of hyper terminal.

2.50 Preparation for operation

The pressure in the refrigeration line / cryo-coil should be equal to the system balance pressure (235 – 250 psi). Fully open the hand valves in this order – Defrost, Cool and Common return (underneath the valve box cover inside the front door). Turn each valve back ¼ turn to prevent the valve sticking in an open position.

Allow 2 minutes for the pressures to equalise. Record the balance pressure from the system display panel. It is expected that the pressure will have dropped. The optimal pressure range is between 235 – 250 psi as displayed on the pressure gauge. If the pressure is higher than this value refrigerant should be reclaimed through the access valve, if lower more gas should be added using a reclaim unit to pump the gas in. • •

CAUTION

Achieving the correct system balance pressure is critical in maximising the potential of your TVP too high a pressure will result in the system over pressure protection being activated, too low and the maximum cooling capacity maybe compromised.

Replace the valve box cover including insulation, check that a good seal is made around the whole of the box. This prevents frosting of the valves during operation. •

Allow water to flow around the system, ensure the flow rate is sufficient for the inlet temperature (See graph).

Apply power to system •

Check all 3 phases are present and that they are roughly equivalent voltages. Damage maybe caused if unit is run with missing / browned out phases.

The TVP requires no neutral, a circuit breaker with a value suitable for the maximum current draw must be selected. A TVP is phase sensitive and may require the phases to be swapped following initial start. The unit has phase protection software, which will cause the unit to stop after about 10 seconds of reverse running is detected. Older models do not have phase protection software.

WARNING

The system contains high voltage (208 or 415VAC) and high power components. To avoid the possibility of a fatal electrical shock always isolate the unit from the mains supply before working on the system. A qualified technician, as for all high power electrical connections, should carry out the electrical work.

If the unit has the wrong phase orientation DP value will not rise, no damage can be caused by short periods of reverse operation. Damage may be caused if you unit is left to run for long periods running backwards.

CAUTION

Check the following before starting the unit. •

Power is supplied to all 3 phases.

Water flow and temperature meet minimum system requirements (see graph)

All hand valves are open.

There is an audible beep followed by a click on power up to the display

DP/SP are balanced in the range 235 to 250psi (assuming CT is above 10°C) make a note of these values

2.51 Starting the unit for the first time

Reset the STOP button after actuation it must be turned 90o clockwise, all other buttons have a momentary action. The TVP will automatically reset after a forced stop, manual start or renewed remote start signal are required for restart. If the unit is ready for operation the green start / standby button will illuminate.

Depress the start / standby button the unit should run, the display should read Pre-cool, check the value for DP rises and the value for SP falls. If the unit has the wrong phase orientation DP/SP values will not change significantly, switch unit off and isolated at supply. Swap two of the phases to correct phase rotations and restart unit, if correctly installed the unit will also run noticeably quieter.

If the unit fails to start check the over pressure trip (diagram 3.) And reset if necessary by sliding the green re0set button. Failure to start may also be caused by the phase protection check software error message on display and restart.

2.52 Evaluation of TVP after initial installation

The water temperature rises (higher outlet vs. Inlet) check flow is in correct orientation
DP rises to more than 400 psi and then drops
SP falls

Coldest temperature (CT) falls rapidly to a value of less than -70°C .

System will enter ready to cool state (green light illuminates) in around 30 minutes from initial start-up. At this point approximately 70% of the maximum cooling capacity is available. A further period of standby until the value of DP is less than 180 psi.

Run system until stable check that:

SP reaches 27 psi or less and DP achieves less than 170 psi. If the water temperature is lower than 20°C values for DP and SP will also be lower. If the value for SP falls below 3 psi during any extended period of Standby operation the system may be short of gas and a leak should be suspected.

WT must be less than 32°C in Standby.

2.53 Cycle the water vapor cryo-trap

The purpose of carrying out several cycles is to induce any small leaks in the couplings before the system enters service. This way maximum productivity is assured.

Cool

Refer to the operation section of this manual, evacuate the vacuum chamber to a depth of 5×10^{-3} mbar (cross over temperature)

The system is ready to cool. Press the COOL button to start cryo-pumping. The CI and CO values will stabilise the temperature differential between CI and CO of up to 20°C is possible when the system is under maximum heat load. The exact differential between CI and CO is dependent upon many factors including the length and quality of the insulation of the refrigeration lines. During a cycle where no heat from in chamber processes is being absorbed the differential should be less than 5°C .

Allow system to stabilise ideally for 1 hour and note system parameters DP, SP, WT, CI, CO and ultimate vacuum level for future reference.

CAUTION

Ensure the cryo-coil is located in a vacuum chamber and that the chamber is evacuated to at least 0.005 Torr or 5×10^{-3} mbar to prevent overheating and excessive frosting of the coil from latent heat.

Defrosting

After cooling the cryo-coil is regenerated by defrosting. This is achieved by pressing the DEFROST button. Note time taken to defrost. During any of the pre production phases it is very useful to use the data logging facility of the TVP for future reference and timings.

NOTE

To reduce the cycle time for any given system it is good practice to use the remote sensors and place them on the refrigeration lines as close as possible to the vacuum feed-through. The best thermal contact is made if the sensors are placed into copper using a thermally conductive grease into sleeves which have in turn been silver soldered directly on to the refrigeration lines.



Diagram 16.
Remote
sensor silver
soldered to
refrigeration
line.

If the system
is to be used

with either the RS232 interface or remote connector, repeat evaluation using your process controller to drive the process. Carry out at least three complete cool/defrost/standby cycles before checking for leaks especially at the couplings to the refrigeration lines.

Re-check the couplings, braze points, etc for any leaks with a halogen leak detector. Leaks if found must be repaired. After any leaks are repaired, re-pressurise the TVP unit as for initial installation and perform the temperature cycling again.

CAUTION

Before any leaks are repaired the refrigerant mixture must be drawn back into the TVP unit. Using an oil free refrigerant reclaim unit. This requires an experienced technician details of how this may be achieved are outside the scope of this manual.

CAUTION

Do not operate the unit if a refrigerant leak is suspected. Be very careful not to achieve a vacuum within the refrigeration lines whilst the hand valves are open, as this will lead to contamination of the system by water.

2.6 Decommissioning

Should it be necessary to remove the TVP from the vacuum system the following procedure must be followed.

Warning

The refrigeration system contains a mixed blend of refrigerants and polio-ester oil. These do not present acute health risks it is essential that the following basic precautions are followed:

- (a) Always wear eye protection.
- (b) Always wear surgical type gloves.
- (c) Only fully trained personnel certified in the handling of refrigerants should attempt to decommission any system containing refrigerants.

Warning

System contains specific hazards, which present a significant danger to personal safety;

- (a) High pressure refrigerant gases, are a significant frostbite hazard.
- (b) Refrigerant gases will cause asphyxiation followed by death in confined areas.
- (c) Refrigerant gases, which if exposed to high temperatures decompose to form very toxic by-products – never smoke in the vicinity of a TVP or any other similar system including the gas cylinders.

Caution

There are strict regulations concerning the recovery and discharge of all refrigerants into the environment. Penalties can be severe if decommissioning is carried out by untrained persons or if release to the environment occurs.

- Run the system in standby mode until the unit reaches a stable value for SP.
- Then close all hand valves. This means ensures that 90% of the refrigerant which is resident in the cryo-coil and lines is recovered back to the TVP.
- Residual gas in the lines must then be reclaimed via the access hand valve to an empty reclaim cylinder using an oil free refrigerant reclaim unit. Care should be taken to not contaminate the reclaimed gas with air.

Note

The reclaimed gas may then be used when the system is reinstalled during the balancing procedure previously described.

Section 3 Trouble shooting guide

3.00 TVP water vapour vacuum pumps are made up of 4 essential sub systems. •

1. Refrigeration system • •
2. Power electrical / Water supply •
3. Low voltage electrical and interface
4. Control electronics

Of these the first two account for almost all system problems. When diagnosing a fault take time to discover and record all system parameters always treat the TVP and related vacuum system as a "black box"

3.01 Alarm messages

Note all alarm messages before resetting unit. Repeated alarm messages can be an indication of imminent system failure or failure of the water supply. •

The system will shut down if control parameters are breached and an error message will be displayed: If a system parameter breached a manual reset is required. •

Error code •	Display message	Means
E1	DP High	Discharge pressure high
E2	SP Low	Suction pressure low
E3	WT High	Water temperature high (greater than 35°C)
E6	DT High	Discharge gas temperature has exceeded 145°C
E7	O/P Switch	System over pressure trip has been triggered
E8	Phase error •	Phase rotation wrong or missing •, or "Over Pressure" switch tripped

3.02 Refrigeration leaks •

These are the number one cause of poor system performance and failure. Almost all leaks in the field are attributable to poor • installation practices.

Checking the system balance pressure •

If a leak is suspected the system should be shut down for a period of approximately 48 hours (or until the value of the CT is greater than 10°C. The values of DP and SP should be taken and compared with the values following installation.

On power up the suction pressure, discharge pressure or water temperature may be outside of acceptable values correct these first before attempting to start the system.

3.03 Topping system up

The TVP should be operated between the design balance pressures of 235 to 250psi. If the pressure falls below these values the system maybe topped up using a top up charge. Part number 75-1000-00 or 75-1100-00. Topping up the system when the pressure has fallen below 130psi is not recommended as critical components may not be replaced by the top up charge.

3.1 Trouble shooting guide – initialisation and start up

Symptom	Possible Cause	<i>Corrective Action</i>
LCD does not illuminate	No system power	Check mains input
	Missing phase – Blue on machine	Check mains input
	EMO not reset	Reset EMO by twisting 90° clockwise
LCD illuminates but start / standby button does not illuminate	Check LCD for error message If unit is running and pre cool is displayed this is a normal condition.	Consult error message guide for possible cause and rectify. Probable cause system pressure or water temperature.
LCD and start / standby illuminated but system does not start when Start is pressed	Over pressure trip has been triggered	Check static pressure is in the range 235 - 250psi. Reset trip and restart. Trip resets with an audible “click”
LCD and Start / Standby illuminates but system does not start when Start is pressed or LCD displays gibberish	There has been a momentary power out check the rest of your plant	Reset EMO by twisting 90° clockwise
System runs and then stops	Check LCD for system status	Most common cause of this is either the value for discharge pressure DP being too high or the suction pressure too low. Check over pressure trip and review system balance pressure.
	There has been a momentary power out check the rest of your plant.	Reset EMO by twisting 90° clockwise
E8 Phase error	Compressor noisy – There is a phase problem.	LCD should gives message E8 Phase error . swap 2 of the phases reset system and restart.
E3 WT High	Check the water temperature does not exceed the pre-set value (35°c) especially during initial cool down or when the system is under full load. At these points the heat dissipated to the water is at its maximum E3 WT High displayed	Most likely cause of cooling water failure is inadequate flow or the cooling capacity of your chiller is too low.
Error message E6 DT	Over temperature protection triggered	Error message E6 DT high should be displayed. Power system down using EMO reset temperature protection and reset system via EMO. If this repeatedly occurs there are two possible causes. <ol style="list-style-type: none"> 1. System is short of gas though leakage 2. System has become contaminated with air during installation

E7 Dp Trip	System mechanical over protection triggered	During initial cool down it is possible the balance pressure was too high the cooling water flow is too low / reversed or there was a problem with the systems off-load valve. Reset system and restart if fault persists allow system to warm up until CT is at least +10 °C and check system balance pressure.
------------	---	--

3.2 Trouble shooting guide – problems during cool

Symptom	Possible Cause	<i>Corrective Action</i>
System does not cool CT fails to get colder than -150°c after 45 minutes in standby	Water temperature too high or too low	Correct water temperature and flow rate reset system
	System has a leak	System should be shut down for a period of approximately 48 hours (or until the value of CT is greater than 10oc. The values of DP and SP should be taken and compared with the values following installation. Locate and repair leak pay attention to all flare and refrigeration line joints before topping system up to recommended pressures.
	If SP is above 45 psi start valve may have become stuck open. Typically CT will also not be lower than -100°c	With valve cover removed and the system powered, check the start valve solenoid becomes magnetised (use screwdriver). If solenoid magnetised switch unit off and restart after 30 minutes. If coil is not magnetised switch unit off. Remove valve solenoid and heat valve gently to 100oc with hot air gun. TVP systems have a patented refrigeration system, which prevents valve problems under normal operation. Almost all solenoid valve problems are traced to poor installation introducing moisture into the vacuum system. If this does not correct fault stop unit allow to warm up for 48 hours and restart.

3.2 Trouble shooting guide – problems during cool cont 1

Symptom	Possible Cause	Corrective Action
System does not cool CT does get colder than -150°C after 45 minutes in standby	Cool valve hand valve is closed or common return (suction hand valve) is closed	Switch off allow valves to return to ambient temperature before attempting to open. Operating valves while cold can cause damage. Occasionally common return (suction hand valve may become stuck down in this case the cryo-coil should be isolated and the procedure for installation should be repeated
	Cool solenoid valve not functioning	With valve cover removed and the system check the cool valve solenoid becomes magnetised (use screwdriver). If solenoid is operational run system in standby remove valve solenoid and heat valve gently to 100°C with hot air gun. Replace solenoid and attempt cooling – TVP systems have a patented refrigeration system, which prevents valve problems under normal operation. Almost all solenoid valve problems are traced to poor installation introducing moisture into the vacuum system
System has poor cooling with large temperature differential between CI and CO	Too much heat is being applied to the cryo-coil	
	Possible refrigeration leak	Check values of SP DP CT WT While in cool, and standby and compare with previous logged values
	Poor system design	Consult Telemark for free application advice. Aim for a cryo-coil, which has low mass, high surface area, low volume and a small resistance to flow.
	Cryo-coil or refrigeration lines have become damaged	It is common for the refrigeration lines to be twisted or damaged. The entire refrigeration circuit should be free from restrictions
	Hand valves not fully open	Check defrost and suction line hand valves have been opened

Symptom	Possible Cause	<i>Corrective Action</i>
System has poor cooling with small temperature differential between CI and CO	Process problem•	The TVP is designed to have a maximum stabilised temperature differential between CI and CO values of 20°C. It is possible for absolute temperatures and in chamber conditions to vary for the following reasons Ambient humidity - Moisture levels in substrate or poor chamber cleaning increasing levels of out-gassing Poor process control especially if substrate heaters are part of your process. If the cross over pressure is too high when the TVP is switched to cool there is a significantly increased heat load – aim for 5×10^{-3} mbar – Consult tables in section 4•
System is slow to cool•		It typically takes 15 – 30 seconds for an appreciable drop in the temperature at CI. This may be longer if remote sensors are being used
	Water temperature too low•	If the cooling water reading WT is lower than 15°C when the system is in standby initial cooling is slowed•
	Damaged refrigeration lines especially the cryo-coil and return refrigerant line	Check line for blockages and twists.
	System is placed in cool too soon after termination of defrost•	The TVP requires some time to liquefy refrigerant to feed the cryo-coil fully when in cool. Try optimising your process by lengthening the standby period following a defrost. Typically 1 minute of extra standby will speed cooling to the base temperature by about 2 minutes•
	Cryo-coil has too big a thermal mass	Redesign cryo-coil using thinner gauge material

3.3 Trouble shooting guide – problems during defrost

System defrosts slowly	Cryo-coil or refrigeration lines have become damaged	It is common for the refrigeration lines to be twisted or damaged. The entire refrigeration circuit should be free from restrictions
	Hand valves not fully open	Check defrost and suction line hand valves have been opened
	Cryo-coil has too big a thermal mass	Redesign cryo-coil using thinner gauge material
System momentarily enters defrost and then terminates to standby	Defrost requested from standby and therefore terminates correctly Controller has identified that CO or SP values are out of range. The CO sensor problem	System will only defrost only if coil is cold. Check value of CO is lower than the defrost termination point defined in cal2309 (default is zero °C.) Adjust set point and SP is greater than 70 psi check water flow direction. Check that the remote sensor connection plug is in place if removed CI and CO sensors will read open circuit value greater than 200 oC Spare sensors are fitted to system and maybe found behind female side of connector shell of remote temperature sensor connection. Check with your service center for details.
System defrosts normally for a period and then stops	Either the defrost or common return hand valve have been damaged by operation whilst they are cold	Consult Telemark service center, repair requires skilled technician to correct.

3.4 Trouble shooting guide – Interface and remote control

System does not respond to remote interface	Has the system switched over from local control to remote?	Check that pin 9 is terminated against a system ground (this is standard inside the remote connector supplied)
	Is the signal given a no volt contact (relay) closure?	TVP system does not recognise voltage inputs or other forms of signal
	System incorrectly wired	There are several traditional interface solutions which pre-existing vacuum plant maybe configured to check the TVP remote interface schematic. Suggested wiring configurations are shown

	There has been a momentary break in the continuity between the vacuum system and the TVP	Check connection look for damaged pins and poor connections – loose wires, within the consumer side of the interface connector shell.
The measured values jump around when the remote is connected	Voltage is being applied to the remote connector to system ground.	Check supplied contacts are at system ground
There is no signal back showing defrost complete	TVP supplied with 24VAC for signalling but pins are isolated zero volt relays	Check a signal is supplied which can be switched.
I only have two available control relays for the system	Not a problem	Since the control hierarchy places cool over defrost. Which terminates automatically on completion. A start stop and a cools no cool signal are required (this assumes that a defrost will always follow cool) the defrost command is made within the remote connector.
Controller displays nonsense	Power failure	Check power supply
	HV / RF electrical interference from vacuum plant	Check interface is earthed and electrically isolated. Use the 10mm earthing stud to make bond between TVP and vacuum system so they are at equal potential.

Section 4. Tables and data

This section is intended to be a primary reference for the installation and operation of Telemark TVP water vapor cryotrap. Details of products are subject to continuous revision and improvement.

- 4.10 Description of electrical supplies, and controls electrical and system schematics
- 4.11 System with side panel removed showing main sub-systems
- 4.20 Interfacing to TVP
- 4.30 Principles of operation
- 4.41 Description of safety systems
- 4.43 Operational pressures and temperatures
- 4.50 Cooling curve of TVP series units (50 Hz)
- 4.60 Recommendations for the design, design and placement of cryo-coils
- 4.70 Recommended spares and complete spare parts list.
- 4.80 Materials safety data sheet

4.10 Description of electrical supplies, and controls electrical and system schematics

The full electrical circuit diagrams are provided as PDF's on the CD-ROM – requires Adobe Acrobat viewer 4.0 or higher.

4.11 System with side panel removed showing main sub-systems



Key

1. Computer mother board
2. System interface board – sensor inputs
3. Main electrical power distribution board
4. External services and interface connection panel

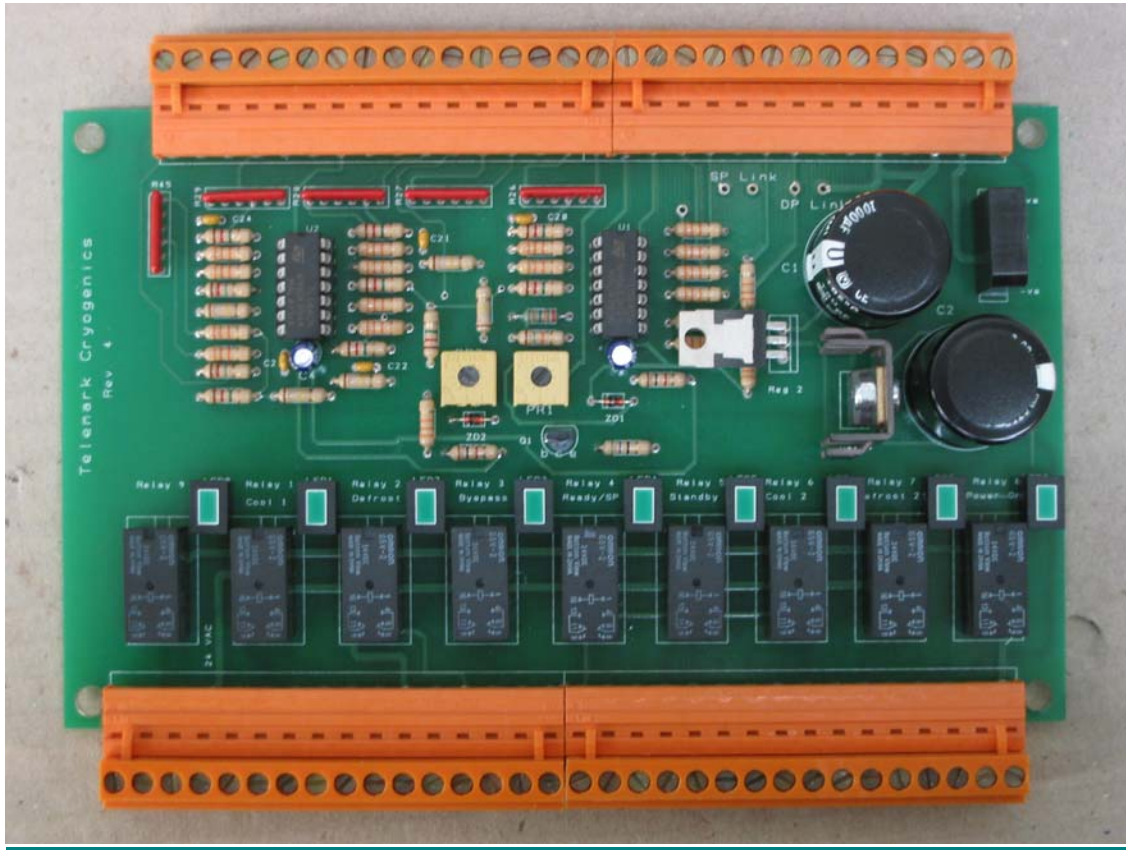

Diagram 17 showing interface board and "snap on / off" edge connectors – see PDF attachments for wiring schematic

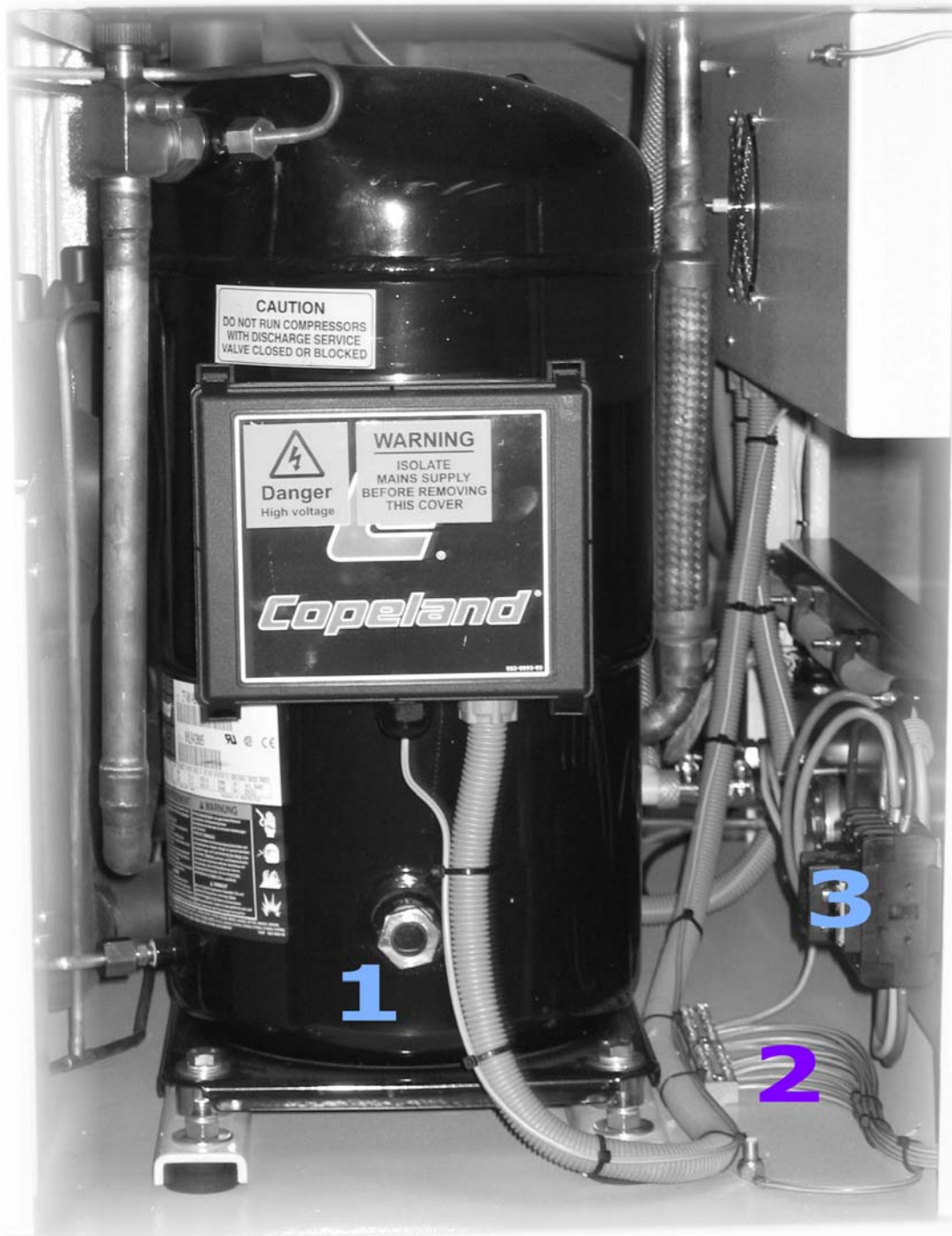

Diagram 18 Front view with door open

Key

1. Compressor oil sight glass
2. Main system isolator
3. Earth distribution (larger 10mm stud supplied for customer earth bonding requirements)



Diagram 19 With left hand side system panel removed.

Key

1. Over-pressure trip (slide green button on top to reset)
2. Discharge line
3. Suction line
4. high stability pressure transducers

Diagram shows side removed for the location of over pressure trip which is more easily accessed by opening the front door of a TVP

4.20 Interfacing to the TVP

The TVP is supplied as standard with a remote interface; connection is via an industry standard 37 pin AMP plug

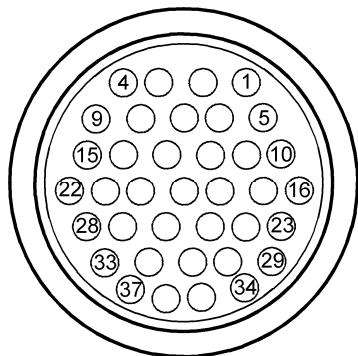

Diagram 20 AMP style 37 pin connector - connector side

The User Interface is automatically enabled when pin 9 is connected to system GND (pin 24); this link is installed in the supplied connector.

When the connector is inserted, the system switches to REMOTE - indicated on the top left of the LCD display. In REMOTE only the "SCROLL" key functions, but all the indicators continue to function (i.e. COOL, DEFROST, STANDBY) along with the RS232 read commands (includes logging).

The system can only be taken out of remote by either removing the connector or by selecting RS232 control via the serial link.

All the remote indicators function at all times regardless of system status i.e. The system can be in LOCAL or RS232.

4.21 Digital Inputs

The digital inputs accept an input voltage with a digital threshold at ~ 2.5 volts. The inputs are protected against overload over a range from -48 to $+48$ volts. These inputs are useful for detecting contact closures or sensing devices with open collector transistor outputs, logic level outputs can also be detected as long as they are from a CMOS logic output guaranteed to swing at least 3.5 volts.

The input has an RC circuit with a 0.2-millisecond time constant to stabilize signals, signals faster than 5khz can be effected.

4.22 Digital Outputs

The digital outputs are fully isolated, they provide a contact closure to ground rated for up to 1A @ 24 VAC. The commons are all linked for the user to connect to ground or apply a voltage (pins 4,6,17,29), a 24 VAC source fused at 2A is provided on pins 35 & 36 to drive external relays.

Suggested Wiring Schemes

[DWG PB200204-1 Suggested interface schematics.pdf](#)

Note the term Low = Closed or connected to gnd

Caution

Interface is fully isolated the indicated GND (ground) is not earth connecting return side of operate relays will induce control errors.

Within the 37-pin remote interface plug supplied with the unit. For your convenience the link between pins 9 and 24 is made this has the effect of automatically forcing the unit into remote mode when ever the interface plug is connected. If the interface plug is to be used purely for data logging the analog output this link must be removed.

Caution

The interface will not accept analogue inputs e.g. Voltages. Applying a voltage to the control pins of the interface will cause control problems. Use additional relays to produce the no-volt contact closures required.

4.23 Basic Interface configuration and control via a single relay

Connecting pin 9 (remote enable), pin 1 (operate unit), pin 13 (operate defrost) to pin 24 (GND). This can all be achieved within the 37-pin remote interface plug supplied with the unit. For your convenience the link between pins 9 and 2 is made this has the effect of automatically forcing the unit into remote mode when ever the interface plug is connected. If the interface plug is to be used purely for data logging the analog out put this link must be removed.

On power up

Unit will be forced into remote by pin 9 being low, it will see pin 1 low and turn on the compressor and start the PRE_COOL cycle.

When the pre-cool is completed the system will go to STANDBY and see pin 13 low, it will then go into a defrost cycle (warm coil, this will terminate when CO reaches the Set point, the Suction pressure goes high or the defrost timer exceeds 5 minutes).

Once defrost is complete the unit will enter the STANDBY state.

To cool

The system needs to require a single closure between 11 and GND, so long as pin 11 is low the system will remain in COOL. When the relay/switch is opened pin 13 will be observed as "low" the TVP will then automatically enter the DEFROST cycle before returning to STANDBY. In this basic scheme the system will always do a complete cycle, i.e. It will perform COOL – DEFROST – STANDBY.

This can be expanded by adding a second switch between pin 13 and GND to select Defrost, here if both switches are open the system is in STANDBY, to select COOL close pin 11 to GND.

To select defrost close pin 13 and then open pin 11.

NOTE the system updates the I/O @ 70 milliseconds, if cool is removed before defrost is applied the system will go into STANDBY momentarily. This can cause a problem for some slow to update systems.

4.24 Full Interface

This shows the complete I/O for the twin coil TVP.

The control inputs are exactly the same as above but with two additional inputs for COOL 2 and DEFROST 2. The digital outputs are shown with either a customer supplied power supply, the internal 24VAC (fused 2A) or the outputs can be connected to system Ground for customer systems with open collector inputs.

Analog Out put

The analog output will show the value of coil out, the output is in the range 1 – 10VDC against system ground open circuit therefore indicates a sensor failure or loss of continuity.

The formula follows;

$$V = 3.3 \cdot (T/25)$$

Where

V = volts

T = Temperature °C

4.25 Interfacing to OEM equipment.

Telemark has experience of a wide number of differing schematics and pin designations used by OEM's around the World. We can provide either pre-wired connections or direct TVP to vacuum system adapters upon request.

Leybold interface

One of the most common vacuum control systems encountered is based upon the Leybold / Balzers / Unaxis type of interface.

The standard Leybold interface places 24VAC from indicate common 24VAC relays are therefore required to isolate operates. Telemark supplies at nominal cost a directly mating adapter for this type of interface.

New systems such as the SYRUS™ manufactured by Leybold Optic gmbH and its affiliates have a different interface configuration.

Interface for SYRUS machine only.

Telemark pin	Leybold pin	Description
1	1	Operates closure with pin 2
2	2	
3	10	Indicate OK
36	5	Indicate common
11	11	Operate cool closure with 2
13	13	Indicate defrost complete
16	12	Operate defrost closure with 2
35 linked to 29		

4.26 Isolated interface schematic

TVP side	Pin	Description	Type	Notes
	1	Operate unit	CC	Zero volt contact closure with any system ground will operate unit
	2	System ground		
	3	Set point relay 1b. (duplicate of pin 28)	SC	Read back signal
	4	Indicate common	SC	Customer supplied signal to be read back
	5	Indicate power	SC	Read back signal
	6			
	7	Frame Earth / Ground		
	8			
	9	Remote enable		link to 24 to place in remote - factory supplied with connector
	10			
	11	Operate cool coil 1	CC	Zero volt contact closure with any system ground will operate unit
	12	Indicate cool coil 1	SC	
	13	Operate defrost coil 1	CC	Zero volt contact closure with any system ground will operate unit
	14			
	15	Indicate defrost coil 1	SC	Read back signal
	16	Indicate defrost complete coil 1	SC	Read back signal
	17	Indicate common		
	18			
	19			
	20			
	21	Operate cool coil 2		
	22	Indicate coil coil 2		
	23	Operate defrost coil 2		
	24			Pre - linked within factory supplied AMP plug to PIN 9
	25	Indicate defrost coil 2		
	26	Indicate defrost complete coil 2		
	27			
	28	Set point relay 1a.		
	29	Indicate common		
	30	Set point relay 2		
	31	Indicate common		
	32	Analog out coil 1 (normally CO)	SO	Range 1 to 10 VDC = -172 to + 60 oC against system ground
	33	System ground	SO	
	34			
	35	24 VAC	SO	AC voltage protected by 2 Amp fuse
	36	24 VAC	SO	AC voltage protected by 2 Amp fuse
	37			

Customer side requirement

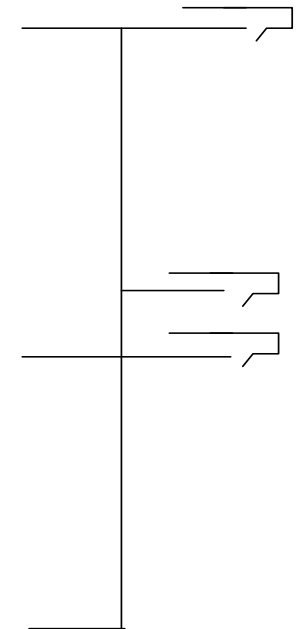

Note
 Voltage passed through an operate or system ground will disrupt the system.
 All operate signals (contact closures) must be voltage free

Key

CC	Customer supplied contact closure
SC	System supplied contact closure
SO	System output

4.30 Principle of operation

For the user and installer the TVP maybe considered as a classical refrigeration system where gas is compressed and cooled to induce condensation to a liquid. The liquefied gas is then passed through a metering device (orifice) causing a pressure drop and subsequent evaporation within a closed volume (cryo-coil) producing a cooling effect. The system differs from a conventional system in that it has several different gases and a complex array of heat exchange surfaces are used to achieve the cryogenic temperature required.

The TVP uses the auto-cascade principle, which achieves low temperatures in a single compressive step. This is different from many other low temperature refrigeration systems, which achieve low temperatures by linking together two or more compressive refrigeration steps to form a classical cascade system. Further background information on auto-cascade systems can be obtained from Telemark.

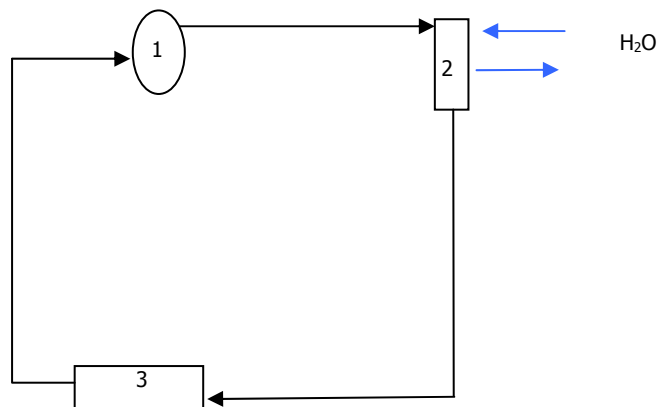

1. Compressor
2. Condenser
3. Evaporator

Diagram 21 Simple refrigeration cycle

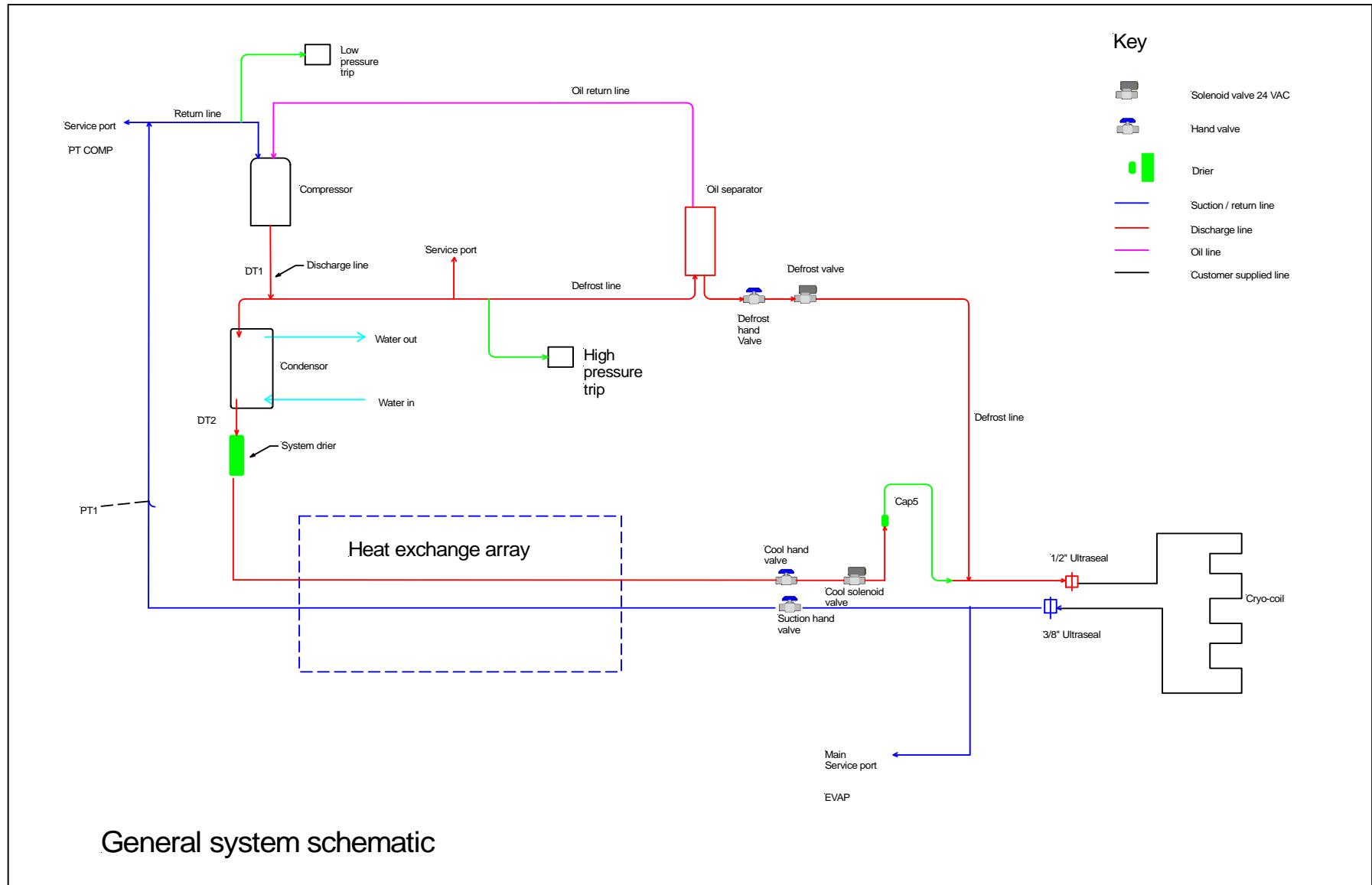

4.40 Description of safety systems

Several types of safety devices protect the TVP. These classified into two functional types, software and hard ware devices. In the scheme of protection the software devices provide first line protection however in many cases where the rate of change is faster than the electronics is capable of processing the primary protection is a mechanical device.

Caution

Understanding the hierarchy of system protection is a very useful aid to trouble shooting, each protection device must be assessed in the case of a forced system shut down.

4.41 Hierarchy and description of protection systems (lowest to highest.)

Software / Electronic protection

1. Coldest temperature prevents cool defrost if too warm.
2. Suction pressure a. Prevents operation below 3 psi system shut down at zero psi.
3. Suction pressure control b. Prevents system start if too low
4. Defrost termination on coil out temperature
5. Defrost termination on time (300 second maximum)
6. Discharge pressure a. Prevents system entering cool, defrost or standby if too high.
7. Discharge pressure b. Terminates defrost if predetermined level exceeded
8. Discharge pressure c. Prevents system switch on if resting pressure limit exceeded.
9. Phase protection determines correct compressor function at start up.
10. Water temperature too high (user adjustable via RS232 commands 20°C – 40°C) preset at 35°C
11. Full sensor and system continuity and compliance test before start button enabled.

Hardware protection

1. Compressor thermal protection auto-resetting if compressor motor winding maximum temperature is exceeded.
2. Overload protection immediate shut down of individual compressor if current exceeds design maximum.
3. Residual current protection (models shipped after 01/06/02) immediate shut down if leakage to earth detected.
4. Discharge temperature immediate shut down if +145°C is exceeded.
5. Discharge pressure immediate shutdown if pressure limit exceeded

Error Code	Message displayed	Meaning
E1	DP High	Discharge pressure too high – limit varies depending upon operational state of system
E2	SP Low	Suction pressure too low – limit varies depending upon operational state of system
E3	WT High	Exit water temperature greater than +35°C- user configurable range +20 to +40°C
E6	DT High	Discharge temperature has exceeded +145°C
E8	Phase Fault	Electrical supply is missing or has a phase reversed.

4.42 Operation temperatures and pressures

The following table gives the typical values, which maybe experienced during the operation of a TVP. It is important to appreciate that the values are influenced strongly by the operational mode and the amount of heat being pumped by the unit. The supply water temperature also has a profound impact when the system is in standby for long periods or where it is operating close to its maximum duty.

Caution

A system operating outside of its design parameters may be harbouring a quiescent system malfunction.

Parameter	Description	Acceptable (normal) range
SP start up *	Suction Pressure	20 to 120 psi
DP start up *	Discharge pressure	100 to 420 psi
SP unit running		7 to 60 psi
SP & DP system off	System balance pressure	235 to 260 psi
CT	Coldest temperature	-100 to -170 °C
WT	Water temperature	35 °C default 20 - 40 °C optional
CI	Coil in temp	+90 °C to -150 °C
CO	Coil out temp	+40 °C to -150 °C

Partial pressure of water vs. Temperature and pumping efficiency

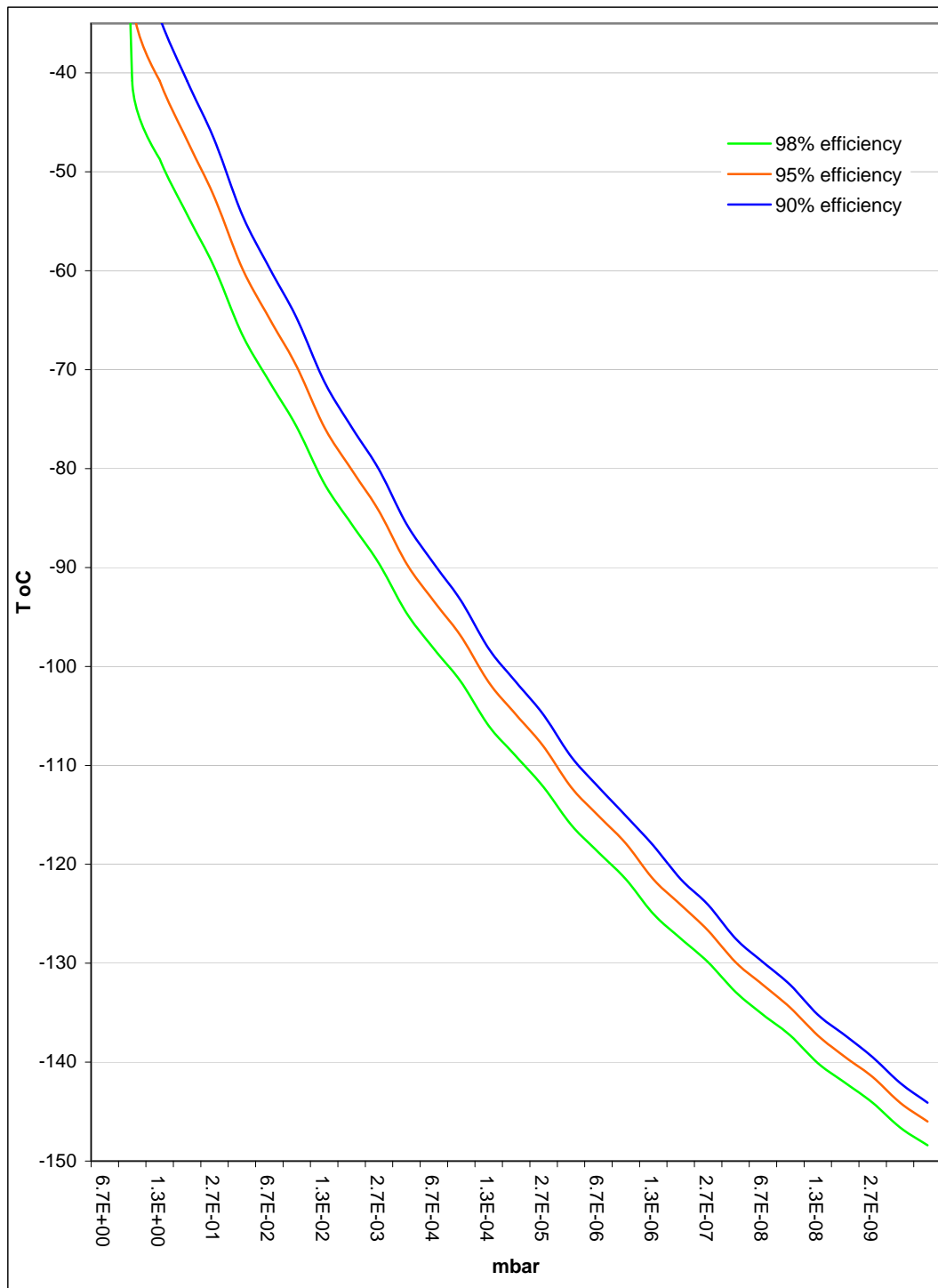

Diagram 23 Pumping efficiency of H₂O at partial pressure (mbar) vs. Temperature °C

Pumping efficiency

Mbar	98%	95%	90%
6.7E+00	-41	-32	-25
2.7E+00	-49	-41	-34
1.3E+00	-54	-47	-41
6.7E-01	-60	-53	-47
2.7E-01	-66	-60	-54
1.3E-01	-71	-65	-60
6.7E-02	-76	-70	-65
2.7E-02	-82	-76	-71
1.3E-02	-86	-80	-76
6.7E-03	-90	-84	-80
2.7E-03	-95	-90	-86
1.3E-03	-98	-93	-90
6.7E-04	-102	-97	-93
2.7E-04	-106	-102	-98
1.3E-04	-109	-105	-102
6.7E-05	-112	-108	-105
2.7E-05	-116	-112	-109
1.3E-05	-119	-115	-112
6.7E-06	-122	-118	-115
2.7E-06	-125	-122	-118
1.3E-06	-128	-124	-122
6.7E-07	-130	-127	-124
2.7E-07	-133	-130	-128
1.3E-07	-135	-132	-130
6.7E-08	-137	-135	-132
2.7E-08	-140	-137	-135
1.3E-08	-142	-140	-137
6.7E-09	-144	-142	-140
2.7E-09	-147	-144	-142
1.3E-09	-148	-146	-144

4.5 Cooling curve TVP models

The cooling curves shown indicates the approximate cooling capacity of the each system operating at 400VAC / 50Hz were the supply is 60Hz the capacity is increased by approximately 15% at any given temperature the "cool – no load temperature" will be reduced by approximately 5 °C.

TVP2000 cooling capacity Watts vs. Average coil temperature @ 400 VAC/50 Hz

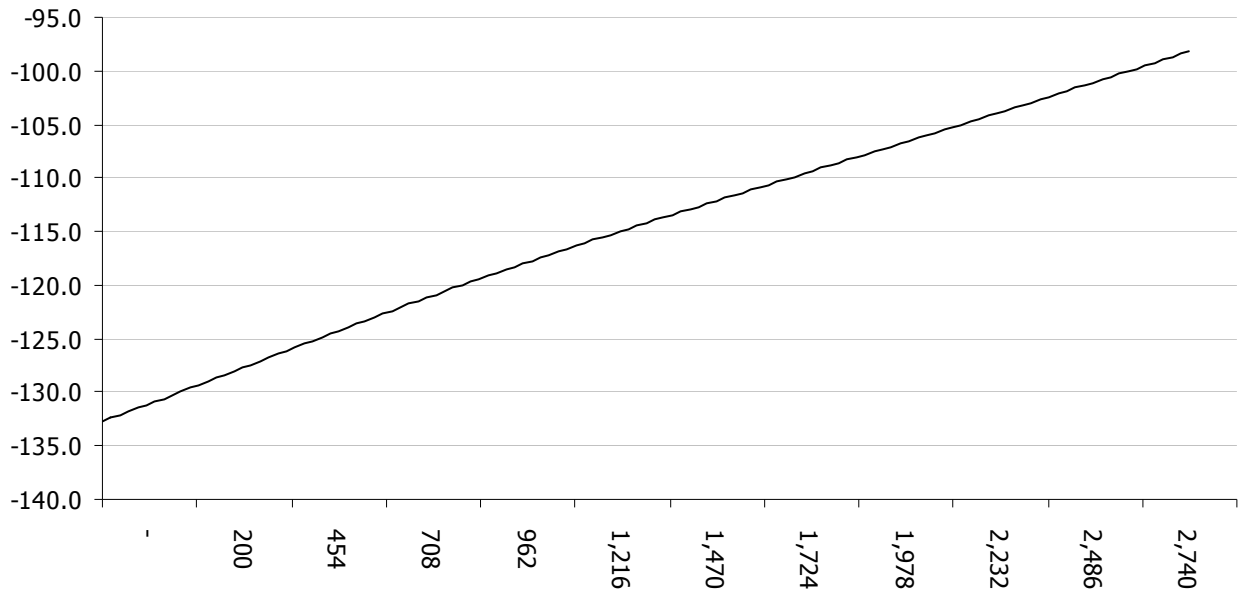

Temp °C

TVP3500 coil average vs heat load

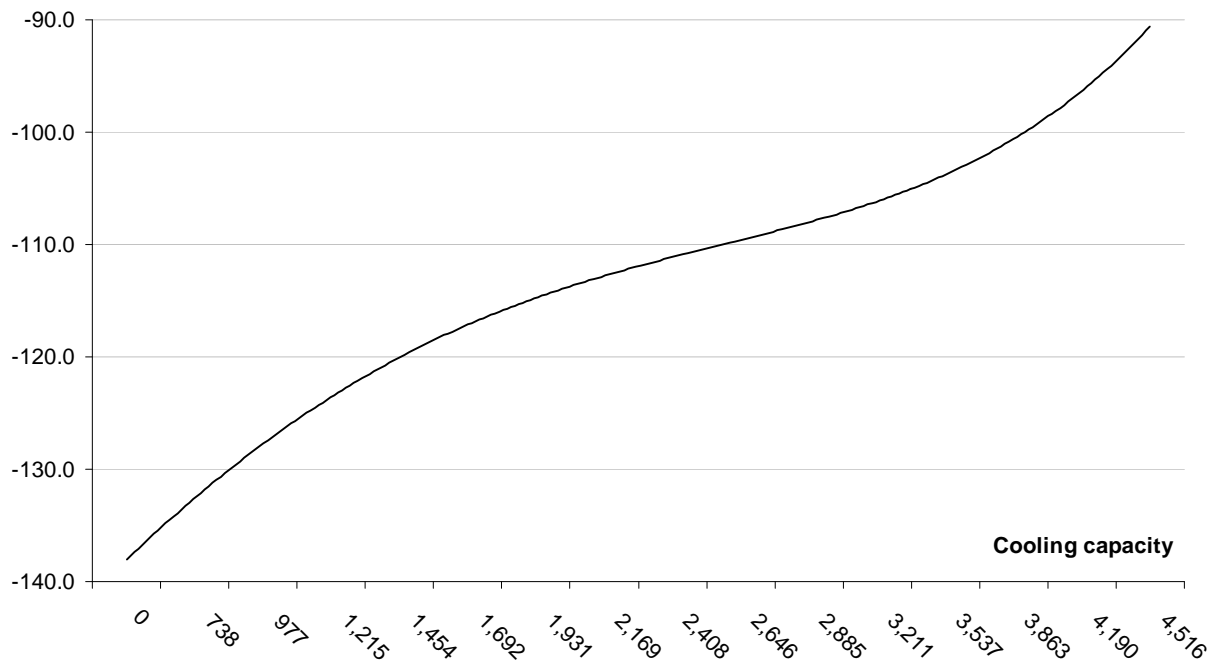

4.60 The design and placement of cryo-coils

Caution

The design and placement of cryo-coils assumes a basic understanding of the principles of vacuum pumping, many good texts on the subject are available. From Leybold, BOC Edwards and other general vacuum equipment suppliers.

It is important to appreciate that a TVP will only pump water efficiently in conditions of molecular flow i.e. In vacuums of less than 1×10^{-3} mbar. Where the pressure exceeds this value before the system is switched to cool there is a risk of over loading and saturating the cryo-surface, which may lead to poor process quality and slower pump downs. The temperature at which the TVP may be placed in cool is known as the crossover pressure and is analogous to the same criteria, which is applied to other forms of secondary pump.

A TVPs performance is conductance limited i.e. Its maximum pumping speed is directly related to the exposed surface, because of the high efficiency of the unit it is generally possible to use larger cryo-surfaces than traditional systems of equivalent power consumption.

Maximum recommended coil surfaces and theoretical pumping speed for water vapour at – 105°C coil average temperature

Unit	Suggested cryo-surface	Theoretical H ₂ O pumping speed	Sustainable H ₂ O pumping speed (30% deration)
TVP2000	1.6 M ²	238,400 l/S	166,880 l/S
TVP3500	2.4 M ²	357,600 l/S	250,320 l/S

The value for the sustainable pumping speed represents a 30% reduction to account for factors such as proximity of system components reducing conductance and the accumulation of ice reducing heat transfer. The de-ration is subjective and unique to each installation and process.

Since the pumping action is a function of temperature the cryo-surface must be designed to minimise heat gains from sources of external heat. In a perfect system all of the heat load placed on the TVP would come from the condensation of water. Internal heat from the mass of the coil also must be removed before the system is capable of pumping therefore a design which uses a thermally conductive material of low mass should be selected.

The construction ideal cryogenic surface

Appropriate surface area for system

Copper or Aluminium construction

Thin wall

Large surface area volume ratio

Internal volume of not less than 0.3 Litre

A pressure drop between the inlet and the outlet of less than 0.3 bar or equivalent to 20M (TVP2000) or 40M (TVP3500) of 12.5mm i.d smooth tubing.

Capable of handling a pressure of 17 bar (250 psi) over temperature range +150 °C to –160 °C.

Simple to clean – coating processes often create large amounts of powdery deposits, which will reduce the efficiency of the TVP.

The most common form of cryo-surface and the simplest to work is 16mm 5/8" refrigeration grade copper tubing the only significant limitation is that as a consequence of a very thick wall the thermal mass is usually high slowing the rate of cooling significantly.

4.61 Location of cryo-surface

The surface should be clear of any moving parts within the vacuum system.

No closer than 25mm to any chamber wall

Out of direct line of sight with heaters or other forms of heat (magnetrons etc) – if this is unavoidable then the surface can be effectively shielded by aluminium foil.

In systems where there is a great deal of water evolved such as roll / web coating of paper and other materials or where the film is moisture sensitive process improvements can be made by placing the cryo-surface close to the point of moisture generation e.g. The unwind area of a web coater.

Consideration should be given to where the trapped water goes once the surface has been defrosted a drain may be required if there is a lot of water.

Do not place refrigerant couplings within the vacuum system.

4.7 Recommended Spare parts list

The spare parts list may be used as a guideline, please note prices are not listed as they can change over time. Please contact Telemark for current pricing and availability.

Note.

Complete top sections and compressor assemblies are available upon request.

Please send your enquiries in the first instance to your nearest service location or direct to Telemark.

Part #	Description of item	Price	Qty
	Gas charge top up and cylinder TVP3500/2000		
	Gas charge and cylinder TVP3500/2000		
	Gas charge and cylinder TVP3500/2000		
	3/8" Ultraseal gland to weldlok socket - 6-6Q1W-SSR		
	3/8" Ultraseal female nut- 6-6BQ-SS		
	3/8" Ultraseal O Ring 321 (silver plated) - 6BQ-SS		
	1/2" Ultraseal gland to weldlok socket - 8-8Q1W-SSV		
	1/2" Ultraseal female nut - 8BQ-SS		
	1/2" Ultraseal O Ring 321 (silver plated) - 8Q0-SS		
	Ultraseal to socket weld connector 88QHWSS		
	Ultraseal to socket weld connector 86QHWSS		
	Scroll comp ZF40K4E TWC220vac3ph50/60Hz- 8516229		
	Scroll compzf33k4e TWC220vac3ph50/60Hz- 8509716		
	Pressure trip - HP man reset KP 5 - 060-117366		
	Hand valve BML105 - 009G012200		
	Hand valve BML 125 - 009G014200		
	1/8" valve with coil/din plug SCE263A240LT		
	Clamp, cable shell size 23 - 411-444		
	Dust cap - ser 1/3/4 shell 23 - 360-2586		
	Pin - 18-16 awg tin plate - 372-383		
	Socket - 18-16 awg tin plate - 372-428		
	Gland - cable A2P 25 - 381-551		
	Fan - 120mm 240v - 498-081		
	Transformer - 50va toroidal - 223-7917		
	Telemecanique Contact 15KW 32amp 24v coil		
	Thermometer assemblies PT100		
	Temperature switch - 228-2614		
	Connector 37 way fix rec-sckts- 160-0910		
	Connector 37 way cable plug - pins - 160-0926		
	Computer interface board		
	Pressure Transducer - PMP1010-3032		
	Connector - shell QM chassis 2 way - 475-381		
	Foam seal pvc BL 6 x 25mm - 205-0883		
	Shipping case		
	1/4" Copper gaskets B2-4 - 1347		
	Access Schrader 1/4" x 1/4" solder - 1554		
	Block contact N/O Telemecanique ZBE-101 - 331-0473		

The reliability of the TVP and a full service inventory means we do not recommend any spare parts are held at customer location apart from a top up charge of gas.

4.8 Material safety data sheet

The Telemark non-flammable mixed blend (melange) of refrigerants is fully compliant with. EC 2037 / 2000 and therefore contains no substances prohibited under the Montreal protocol or subsequent prohibitions regarding damage to stratospheric ozone.

Safety Data Sheet - Non Ozone depleting refrigerant

Product Name Telemark EC 2037 / 2000 Cryogenic Refrigerant
Part numbers TVP2000 75-1020-05 TVP3500 75-1035-05

Version V01.06

1 Product and company identification

Product name Telemark EC 2037 / 2000 Cryogenic Refrigerant
Supplier Telemark Cryogenics
Address 1801 SE Commerce Avenue
Battle Ground, WA 98604 USA
Telephone 360-723-5360
Fax 360-723-5368
EMERGENCY TELEPHONE 800-424-9300 (North America) 703-527-3887 (International)

2 Composition

Name	Molecular formula	CAS No:	EINECS / EC No:
Proprietary blend of HFC (hydro fluorocarbon) refrigerant gases	N/A	N/A	N/A
Inert Gas	N/A	N/A	N/A

3 Hazards identification

Asphyxiant
Possible slight narcotic effects at high concentration
Uncontrolled release from pressurised container severe frostbite hazard
Pressurised gas
Toxic decomposition products avoid fire, smoking and high temperatures

4 First aid measures

Inhalation
In high concentration may cause asphyxiation
Symptoms may include loss of mobility/consciousness
Victim may not be aware of asphyxiation
In low concentrations may cause narcotic effects
Symptoms may include dizziness, headache, nausea and loss of co-ordination.
Move the affected person to fresh air
Make affected person rest and keep warm
Oxygen or artificial respiration should be administered if breathing stops
Call a doctor immediately

5 Fire fighting measures

Material non-flammable
Decomposition products toxic or harmful wear breathing apparatus, Possible products of decomposition include carbon monoxide, hydrogen fluoride, fluoro-phosgene.

6 Accidental release measures

Ensure ventilation – vapour significantly heavier than air and may accumulate in low-lying areas.
Wear eye protection
PVC gloves to protect against cold surfaces

7 handling and storage

Compressed gas Non-toxic
Non-flammable
Keep container closed
Avoid temperatures above 30°C
Protect containers from weather.

8 Exposure and personal protection

Ensure adequate ventilation; wear breathing apparatus in confined spaces or low-lying areas where vapour may have accumulated.
Wear eye protection
Wear PVC gloves
Material non-toxic non-flammable.

9 Physical and chemical properties

Form	liquefied compressed gas
Color	Colorless
Odor	Slightly ethereal
Melting point	gas
Boiling point	-128°C (R14 component)

10 Stability and reactivity

Stability	Stable at ambient temperature and under normal conditions of use
-----------	--

Hazardous reactions	
- Conditions to avoid	May decompose: - on contact with hot surfaces and flames

- Materials to avoid	No dangerous reaction known with common products
----------------------	--

Decomposition products toxic or harmful, possible products of decomposition include carbon monoxide, hydrogen fluoride, and fluoro-phosgene

11 Toxicological information

Acute toxicity	Vapours LC 50 inhalation (Rat) / 4 h: >20 mg/l. LD 50 oral (Rat): > 5000 mg/kg.
----------------	--

Acute symptoms	Effects following high level exposure: Headaches Dizziness Loss of consciousness
----------------	---

Local effects	May be irritating to the respiratory system Repeated or prolonged contact may cause slight irritation to the skin
---------------	--

Further information	Not classified as hazardous according to EEC criteria
---------------------	---

12 Ecological information

Behavior in the environment	Product is volatile when in aqueous solution
Persistence / Degradability	Very slightly biodegradable
Bioaccumulation	Not bioaccumulable
Destination of the product	Ultimate destination of the production: AIR
General	No known ecological damaged caused by this product Not covered by the Montreal Protocol.

14 Transport regulations

Proper shipping name	Refrigerant Gas, n.o.s. (CAS No's 1885-48-9, 7440-37-1, 74-84-0, 354-33-6, 75-73-0, 75-46-7)
UN Number	1078
Class / Division	2.2
ADR/RID Item No	2.1A
ADR/RID Hazard Number	20
Labelling	Label 2: non flammable non-toxic gas

Other information

Avoid transport on vehicles where the load space is not separated from the drivers compartment.

Ensure the vehicle driver is aware of the potential hazards of the load and knows what to do in the event of an accident or emergency.

Before transporting product containers ensure that they are firmly secured and:

- cylinder valve is closed and not leaking
- valve outlet cap nut or plug (where provided) is correctly fitted
- there is adequate ventilation
- compliance with applicable regulations

15 Regulations

Number in Annex 1 of DIR 67/548	Not included in Annex 1
EC Classification	Not classified as a dangerous substance
EC labelling	No EC labelling required

Disposal

Used cylinders must be disposed of safely, empty cylinders may also be returned to the manufacturer for re-cycling or disposal.

16 Other information

- Separate health and safety data for components is available on request.
- Product is considered safe only when used as a refrigerant charge for Telemark TVP water vapor cryotrap all other uses are at personnel's own risk.
- It is assumed that the material is used only by competent persons who have achieved certification in the safe handling of refrigerants

Material Safety Data Sheet

Product Name Telemark 2000 Cryogenic Refrigerant Charge (Standard)

Version 01.06

1 Product and company identification

Product name Telemark 2000 Cryogenic Refrigerant

Supplier Telemark Cryogenics
Address 1801 SE Commerce Avenue
Battle Ground, WA 98604 USA
Telephone 360-723-5360
Fax 360-723-5368
EMERGENCY TELEPHONE 800-424-9300 (North America) 703-527-3887 (International)

2 Composition

Name	Molecular formula	CAS No:
Proprietary blend of HFC (hydro fluorocarbon) refrigerant gases	N/A	N/A
Inert Gas	N/A	N/A

3 Hazards identification

Asphyxiant
Possible slight narcotic effects at high concentration
Uncontrolled release from pressurised container severe frostbite hazard
Pressurised gas
Toxic decomposition products avoid fire, smoking and high temperatures

4 First aid measures

Inhalation
In high concentration may cause asphyxiation
Symptoms may include loss of mobility/consciousness
Victim may not be aware of asphyxiation
In low concentrations may cause narcotic effects
Symptoms may include dizziness, headache, nausea and loss of co-ordination.
Move the affected person to fresh air
Make affected person rest and keep warm
Oxygen or artificial respiration should be administered if breathing stops
Call a doctor immediately

5 Fire fighting measures

Material non-flammable
Decomposition products toxic or harmful wear breathing apparatus, Possible products of decomposition include carbon monoxide, hydrogen fluoride, fluoro-phosgene.

6 Accidental release measures

Ensure ventilation – vapour significantly heavier than air and may accumulate in low-lying areas.
Wear eye protection
PVC gloves to protect against cold surfaces

7 handling and storage

Compressed gas Non-toxic
Non-flammable
Keep container closed
Avoid temperatures above 30°C
Protect containers from weather.

8 Exposure and personal protection

Ensure adequate ventilation; wear breathing apparatus in confined spaces or low-lying areas where vapour may have accumulated.
Wear eye protection
Wear PVC gloves
Material non-toxic non-flammable.

9 Physical and chemical properties

Form	liquefied compressed gas
Color	Colorless
Odor	Slightly ethereal
Melting point	gas
Boiling point	-128°C (R14 component)

10 Stability and reactivity

Stability	Stable at ambient temperature and under normal conditions of use
-----------	--

Hazardous reactions	
- Conditions to avoid	May decompose: - on contact with hot surfaces and flames

- Materials to avoid	No dangerous reaction known with common products
----------------------	--

Decomposition products toxic or harmful, possible products of decomposition include carbon monoxide, hydrogen fluoride, and fluoro-phosgene

11 Toxicological information

Acute toxicity	Vapors LC 50 inhalation (Rat) / 4 h: >20 mg/l. LD 50 oral (Rat): > 5000 mg/kg.
----------------	---

Acute symptoms	Effects following high level exposure: Headaches Dizziness Loss of consciousness
----------------	---

Local effects	May be irritating to the respiratory system Repeated or prolonged contact may cause slight irritation to the skin
---------------	--

Further information	Not classified as hazardous according to EEC criteria
---------------------	---

12 Ecological information

Behavior in the environment	Product is volatile when in aqueous solution
Persistence / Degradability	Very slightly biodegradable
Bioaccumulation	Not bioaccumulable
Destination of the product	Ultimate destination of the production: AIR
General	No known ecological damaged caused by this product Not covered by the Montreal Protocol.

14 Transport regulations

Proper shipping name	Refrigerant Gas, n.o.s. Tetrafluoromethane, Argon
UN Number	1078
Class / Division	2.2
ADR/RID Item No	2.1A
ADR/RID Hazard Number	20
Labelling	Label 2: non flammable gas

Other information	Avoid transport on vehicles where the load space is not separated from the drivers compartment. Ensure the vehicle driver is aware of the potential hazards of the load and knows what to do in the event of an accident or emergency. Before transporting product containers ensure that they are firmly secured and: <ul style="list-style-type: none">- cylinder valve is closed and not leaking- valve outlet cap nut or plug (where provided) is correctly fitted- there is adequate ventilation- compliance with applicable regulations
-------------------	--

15 Regulations

Number in Annex 1 of DIR 67/548	Not included in Annex 1
EC Classification	Not classified as a dangerous substance
EC labelling	No EC labelling required
Disposal	Used cylinders must be disposed of safely, empty cylinders may also be returned to the manufacturer for re-cycling or disposal.

16 Other information

- Separate health and safety data for components is available on request.
- Product is considered safe only when used as a refrigerant charge for Telemark TVP water vapor vacuum pumps all other uses are at personnel's own risk.
- It is assumed that the material is used only by competent persons who have achieved certification in the safe handling of refrigerants

4.90 DECLARATION OF CONFORMITY

Telemark Cryogenics
1801 SE Commerce Avenue
Battle Ground, WA 98604 USA

Declares that the products:

320-0012-1	TVP2000 200-230VAC/3ph/50-60Hz CE
320-0012-2	TVP2000D (Dual Circuit) 200-230VAC/3ph/50-60Hz CE
320-0014-1	TVP2000 380-440VAC/3ph/50-60Hz CE
320-0014-2	TVP2000D (Dual Circuit) 380-440VAC/3ph/50-60Hz CE
335-0012-1	TVP3500 200-230VAC/3ph/50-60Hz CE
335-0012-2	TVP3500D (Dual Circuit) 200-230VAC/3ph/50-60Hz CE
335-0014-1	TVP3500 380-440VAC/3ph/50-60Hz CE
335-0014-2	TVP3500D (Dual Circuit) 380-440VAC/3ph/50-60Hz CE

To which this declaration relates are in conformity with the following standards or other normative documents:

EN 292	Safety of Machinery; Basic Concepts, General Principles for design.
EN50081-1	Electromagnetic Compatibility, General Emission Standard. Generic Standard Class: Domestic, Commercial and Light Industry.
EN50082-1	Electromagnetic Compatibility, General Immunity Standard. Generic Standard Class: Domestic, Commercial and Light Industry.
IEC1010-1	Safety Requirements for Electrical Equipment for Measurement Control and Laboratory Use.

Following the provisions of:

89/392/EEC	Machinery directive
89/336/EEC	Electromagnetic compatibility directive
73/023/EEC	Low voltage directive
97/23/EC	Pressure equipment directive
98/37/EC	Machinery Directive, Annex 1
EN 60204	
89/336/EEC	Low Voltage Directive, EN 60204-1 (Including, but not limited to):
- IEC 60204-1 4.4.2	
- IEC 60204-1 5.3.4	
- IEC 60204-1 7.2.2	
- IEC 60204-1 7.2.7	
- IEC 60204-1, 14.2	
- IEC 60204.1, 17.4	
- IEC 60204-1, 18	
EN61000-6-2: 2001	
- EN61000-4-2 Electrostatic Discharge at 4kV Contact and 8kV Air	
- EN61000-4-3 Radiated Immunity at 10V/m	
- EN61000-4-5 Surge at 1kV differential and 2kV common mode	
EN61000-6-4: 2001	
- EN55011 Class A Group 1 Radiated Emission	
- EN55011 Class A Group 1 Conducted Emission	

David Fyfe
Manufacturing Manager

November 2, 2006/ Novato, California
Date and Place

表1 有毒有害物质或元素名称及含量标识格式
(Chinese Hazardous Substances Concentration Table)

Telemark Cryogenics Water Vapor Cryotrap Models:
TVP1000, TVP2000, TVP2000D, TVP3500, TVP3500D

Declaration of Hazardous Substance						
Part Name 部件名称	Toxic or hazardous Substances and Elements 有毒或有害物质或元素					
	Lead (Pb) 铅	Mercury (Hg) 汞	Cadmium (Cd) 镉	Hexavalent Chromium (Cr (VI)) 六价铬	Polybrominated biphenyls (PBB) 多溴联苯	Polybrominated diphenyl ethers (PBDE) 多溴二苯醚
Water Vapor Pump TVP1000, TVP2000 or 2000D, TVP3500 or TVP3500D 水汽泵	X	X	X	X	X	X
Compressor 压缩机	X	X	X	X	X	X
Accessory 辅助部件	X	X	X	X	X	X

O: Indicates that this toxic or hazardous substance contained in all of the homogeneous materials for this part is below the limit requirement in SJ/T11363-2006.
O: 表示该有毒有害物质在该部件所有均质材料中的含量均在SJ/T11363-2006规定的限量要求以下。

X: Indicates that this toxic or hazardous substance contained in at least one of the homogeneous materials used for this part may be, or is, above the limit requirement in SJ/T11363-2006. (Enterprises may further provide in this box technical explanation for marking "X" based on their actual conditions.)
X: 表示该有毒有害物质至少在该部件的某一均质材料中的含量超出SJ/T11363-2006规定的限量要求。(企业可在此处, 根据实际情况对上表中打“X:”的技术原因进行进一步说明。

5.0 Limited Warranty for Telemark Water Vapor Cryotrap

Telemark Water Vapor Cryotrap products are warranted to be free from defects in materials and/or workmanship under normal usage for period of one year from the date of shipment. Telemark's obligation under this Warranty is limited to the repair or replacement, at its option, of any parts, which upon examination at the Telemark factory or by an authorised sales/service representative, shall appear to have become defective. Correction of defects by repair or replacement shall be either at the Telemark factory or in-situ by an authorised service representative. The location of repair shall be at the discretion of Telemark. Repairs carried out at Telemark factory shall be FOB Telemark factory and shall constitute fulfilment of obligations to the purchaser. All transportation costs for defective parts or products shall be borne by the purchaser. Telemark will not be liable for loss, damage, or other expenses directly or indirectly arising from the use of its products or from any other causes. Telemark assumes no liability for expenses or repairs made outside of its factory by non-authorised personnel.

All claims on account of defective material or workmanship shall be deemed waived unless made in writing within the aforementioned warranty period. The foregoing Warranty is in lieu of all other warranties expressed or implied. Telemark neither assumes nor authorises any other person to assume any other obligation or liabilities in conjunction with the sale of its products. This Warranty shall be void if the equipment has been subject to misuse, negligence or application outside of recommended operating environment or conditions. The Warranty will also be invalidated if the identification numbers of the system have been altered, defaced or removed.

The Warranty is not intended to support or extend any statutory rights the purchaser may have.

Contact / environmental information

It is the owners responsibility to dispose of the product and its packaging with the highest regard to environmental protection. Specifically all of the gas charge must be recovered and returned to a suitable collection point for reclamation and recycling. Contact your local or national governmental agency for legislation regarding the system.

If further information is required regarding the product please contact the following:

Telemark
1801 SE Commerce Avenue
Battle Ground, WA 98604 USA
Tel: 360-723-5360
Fax: 360-723-5368

sales@telemark.com

Failure to complete and return this warranty card by the end user will void warranty cover from Telemark

Serial Number *Model* *Part Number*

Contact Name	
Company	
Address 1	
City / Town	
State	Country
Telephone	Fax
Email	

Date of delivery

Date of installation

Vendor

Application description